

universal extendable metal curtain pole kit

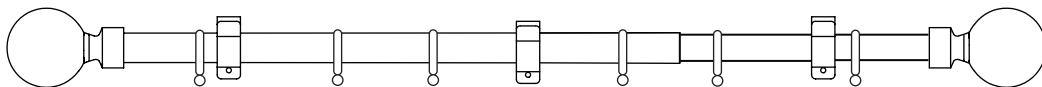

Fitting Instructions

Before fitting your new curtain pole, please read the following instructions and check the contents of your pack against the table below.

Parts		Pole Length	
		120cm to 200cm	180cm to 320cm
1	Pole	1	1
2	Bracket	3	3
3	Finial	2	2
4	Rings	20	32
5	Fittings pack	1	1

Additional rings sold separately

Should any component be missing, please call the Customer Care Department on **0330 005 2233**

Installation & Assembly

You'll need these basic tools:

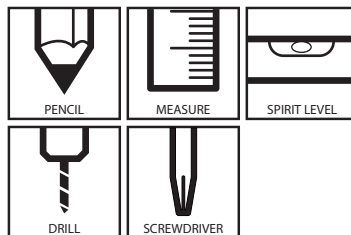

Safety Recommendation

Only use a Step Ladder to install this product. DO NOT over reach. Always move the Step Ladder so that you are in a safe working position. DO NOT hold or lean on the pole to support your weight.

We recommend you use two people for installation of larger poles.

Take care when using power tools, use of a Residual Current Device (RCD) is recommended. Always use eye protection when drilling. Beware of hidden pipe runs and cables.

No liability will be accepted for damage or injury caused by incorrectly installed or assembled product.

PLEASE KEEP OUT OF THE REACH OF YOUNG CHILDREN. SMALL PARTS - CHOKING HAZARD

PLEASE KEEP THESE INSTRUCTIONS AND THE BATCH CODE ON THE PACKAGING FOR FUTURE REFERENCE IF ANY QUERIES

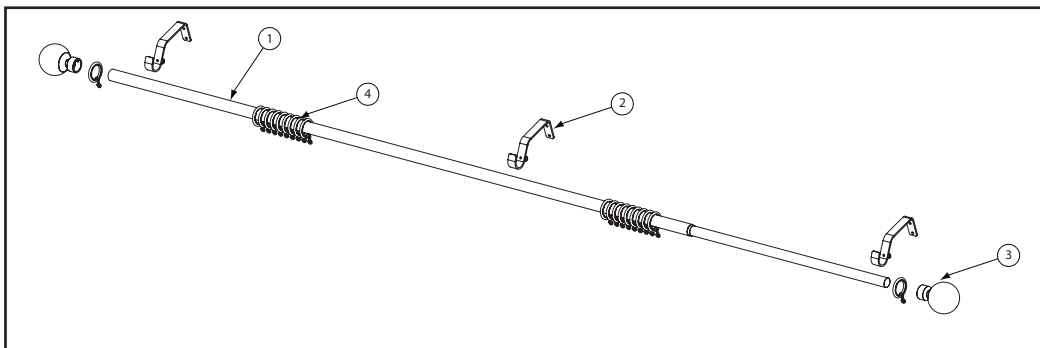

Measure the windows

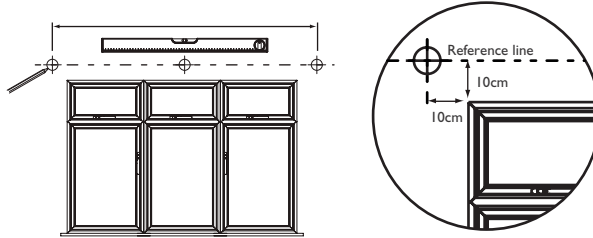

1

Measuring the bracket hole position

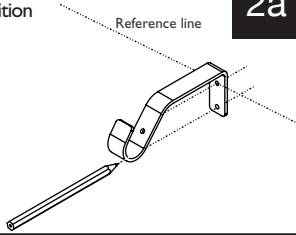

2a

Drill the hole and fit the correct plugs if fixing on masonry wall

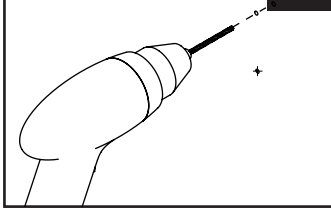

2b

Fix the brackets

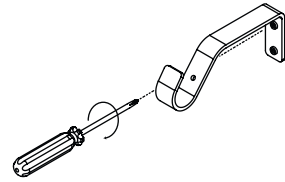

2c

Calculate the length of the pole

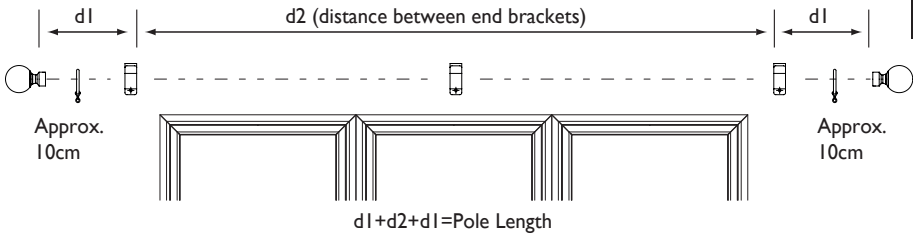

3

Adjust the length of the pole

Slide the inner pole out of the outer pole, take care to leave the joining piece in place between two poles.

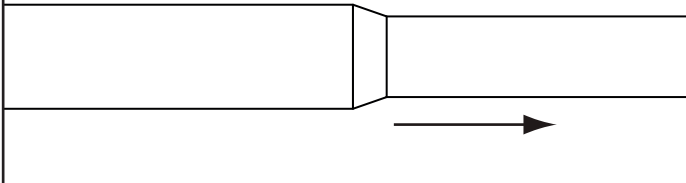

4

Slide on the rings, ensuring an equal amount each side (leaving 2 rings aside)

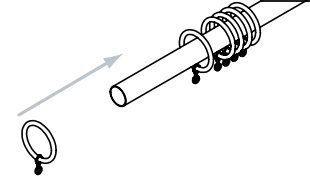

5

Fit the pole into the brackets

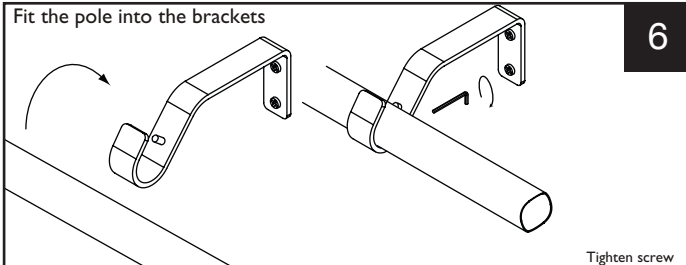

6

Tighten screw

Fit the finial (place the remaining ring between the brackets and the finial)

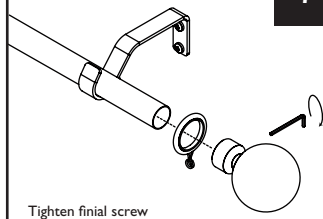

7

Tighten finial screw

6614L

Sunflex, Keys Park Road, Hednesford, Cannock, WS12 2FR
• tel: +44 (0)330 005 2233 • fax: +44(0) 1543 279505
• email: enquiries@sunflex.co.uk • web: www.universal-products.co.uk