

SWISH DESIGN STUDIO POLE KIT

Fitting Instructions

Please keep for future reference

Tools required



Please read these instructions carefully and check the contents of the pack before attempting to assemble and fix this product.

Pack Content

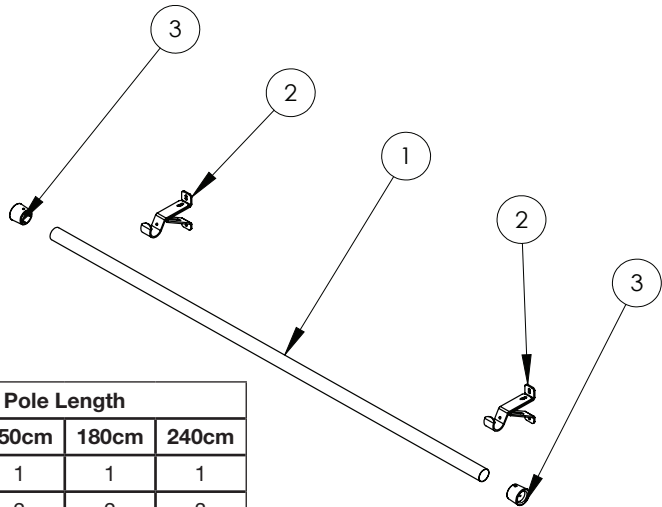

		Pole Length			
Parts		120cm	150cm	180cm	240cm
1	Pole	1	1	1	1
2	End Bracket	2	2	2	3
3	Standard Collar	2	2	2	2

Should any component be missing, please call the Customer Care Department on **0330 005 2233**.

Safety Recommendation

Only use a Step Ladder to install this product.

DO NOT over reach. Always move the Step Ladder so that you are in a safe working position.

DO NOT hold or lean on the pole to support your weight.

We recommend you use two people for installation of larger poles.

Take care when using power tools, use of a Residual Current Device (RCD) is recommended.

Always use eye protection when drilling. Beware of hidden pipe runs and cables.

No liability will be accepted for damage or injury caused by incorrectly installed or assembled product.

PLEASE KEEP OUT OF THE REACH OF YOUNG CHILDREN. SMALL PARTS - CHOKING HAZARD
PLEASE KEEP THESE INSTRUCTIONS AND THE BATCH CODE ON THE PACKAGING FOR FUTURE
REFERENCE IN CASE OF ANY QUERIES

Fitting Recommendation

We recommend for better support to fit the pole to a secure wooden batten which is larger than the width of the backplate. (fig.1)

If you are unsure if the product is suitable please ask advice from a professional builder or your DIY store.

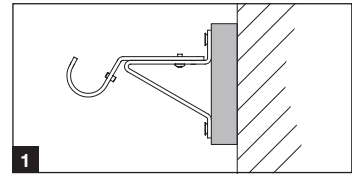

Measuring the Window (fig.2)

- For wall fixing, position the line representing the centre of the pole approx. 10cm from the top of the window.
For ceiling fixing (applicable only when using top fix brackets sold separately), mark the desired position away from the window leaving enough projection for the curtain to move.
- Position the centre of the brackets approx 10cm from the side of the window. If fitting a centre bracket for either heavyweight curtain or double pole length (see joining your pole) centre it in line with the centre of your window.

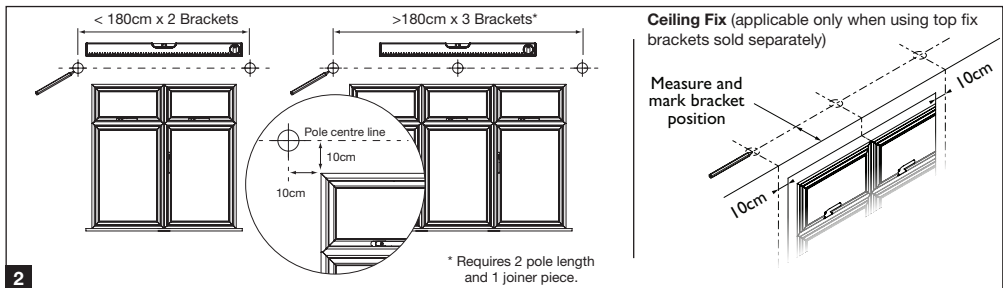

Note: Use the correct wall plugs and screws for the type of wall or ceiling to which you are mounting your pole. If you are unsure please consult your local builders merchant or DIY store.

Wall Fixing the Bracket

- Mark the top hole position for each bracket by 2.95cm above the pole centre line previously marked. (fig.3)
- Use the bracket as a template to mark the second hole position onto the wall. (fig.4)
- Drill holes and fit the correct plugs if fixing on masonry wall.
- Fix the bracket using the correct screws. (fig.5)
- The bracket can be adjusted in projection by unscrewing the inner screw. Once in the desired position, lock in place by tightening the inner screw. (fig.6)

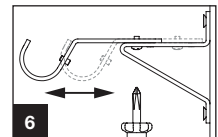
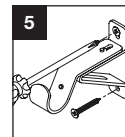
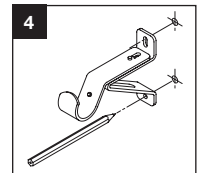
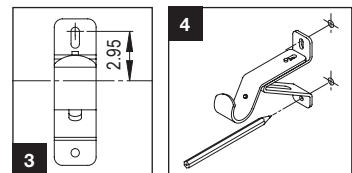

Ceiling Fixing the Bracket (sold separately)

- The bracket can be adjusted to 3 positions by unscrewing the inner screw completely and tightening it back in the next available position. (fig.7)
- Mark the front hole position for each bracket offset from the pole centre line previously marked (fig.8a) as per table.
- Use the bracket as a template to mark the second hole position onto the ceiling. (fig.8b)
- Drill holes and fit the correct plugs if fixing on masonry ceiling.
- Fix the bracket using the correct screws. (fig.9)

Pole size	Hole offset
19	2.9cm
28	2.1cm
35	1.1cm

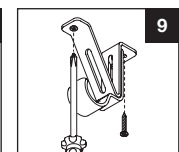
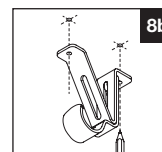
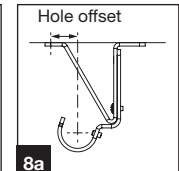
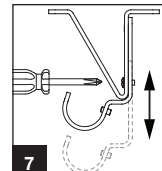

Fixing the pole

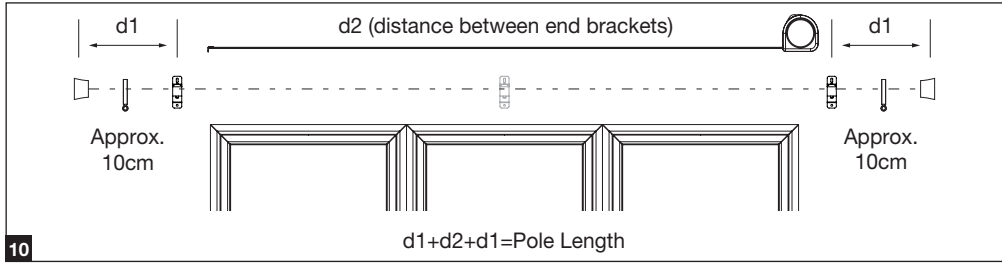

1. Calculate the length of the pole. (fig.10)
2. Mask area to be cut to avoid damaging pole. (fig.11)
3. When using two poles cut equal lengths from each pole. (fig.12)
4. File sharp edges to avoid injury or damage to other components. (fig.13)

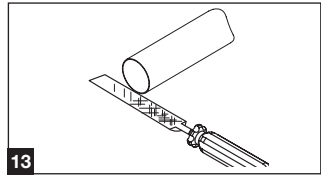
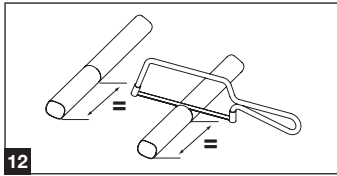
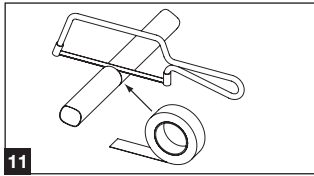

Joining poles (fig.14)

1. Join poles if required by sliding a joining piece into the uncut end of a pole.
2. Slide the second pole onto the joining piece taking care to push equal lengths of the joiner into each pole.
3. Always join the uncut ends of the pole.
4. Pole joints should always be at the half way point of the installation length and supported with a bracket.

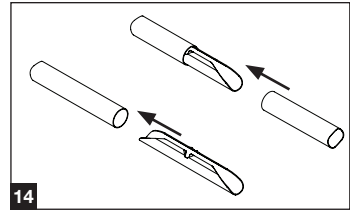

Preparing the curtain (fig.15)

Standard Curtains

1. Leave 2 rings aside, slide the remaining rings onto the pole, approximately 1 ring per 10cm of pole.
2. When using a centre bracket an equal number of rings will need to be used either side of the bracket.

Eyelet & Tab Top Curtains

1. Slide the curtain onto the pole before fitting the pole to the brackets.
2. Leave the last eyelet or loop hanging from the end of the pole.
3. When using a centre bracket a curtain will need to be hung from each end of the pole.

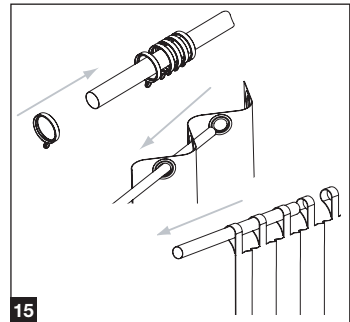

Fixing the pole (fig.16)

1. Loosen the grub screw on the bracket.
2. Place pole in bracket.
3. Tighten the grub screw until the pole does not slide in the bracket.

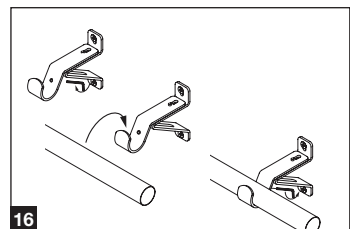

Fixing the collar (fig.17)

1. For standard curtains, position one ring between the bracket and the collar. For eyelet & tab top curtains, position one loop or eyelet between the bracket and the collar.
2. Push the collar onto the end of the pole.
3. Tighten the grub screw on the collar.

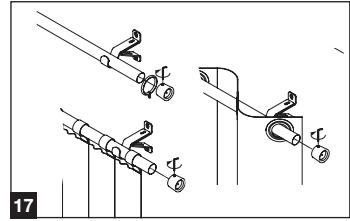

Fixing the finial

1. If the collar is already installed on the pole, unscrew the grub screw and remove the collar. We do not recommend to install the finial while the collar is installed as it could scratch the pole. (fig.18)
2. Screw the finial on the cup end of the collar. Please note that different design are available through the range. (fig.19)

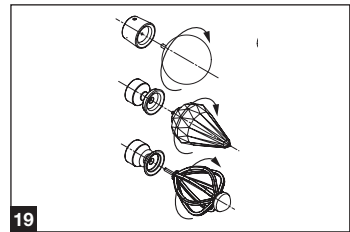
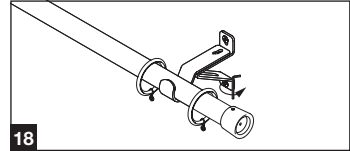

3. Push the finial onto the end of the pole. (fig.20)
4. Tighten the grub screw on the collar.

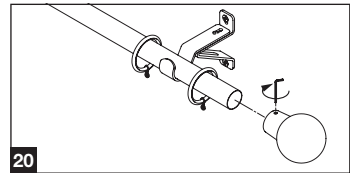

Installing the curtain

1. Equally space curtain hooks along curtain header, you will require one hook for every ring. (fig.21)
2. Place hooks through the eyelet on the ring.
3. Test the installation by drawing the curtains across the pole. (fig.22)

