

# Hand Operated Curtain Track Systems





# Hand Operated Curtain Track System

## Silent Gliss® 1070



### Product Information

- Operation: hand drawn
- Range: S
- Fitting: ceiling
- Colours: white
- Shape: square
- Bendable



1070

## Profile and Bending Information

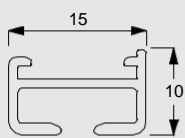

1071

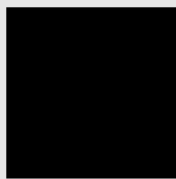

Radius: 8 cm, 12 cm, 16 cm,  
>25 cm

Specification text:

Silent Gliss SG 1070 Hand Drawn Curtain Track System. Comprises aluminium profile SG 1071 supplied made to measure powder coated white, with gliders SG 3533 at 16/m and 2 end covers SG 1072 and 2 end stops SG 3016 per length. Top fixed with clamps SG 3060 at max. 300 mm centres.

## How To Measure

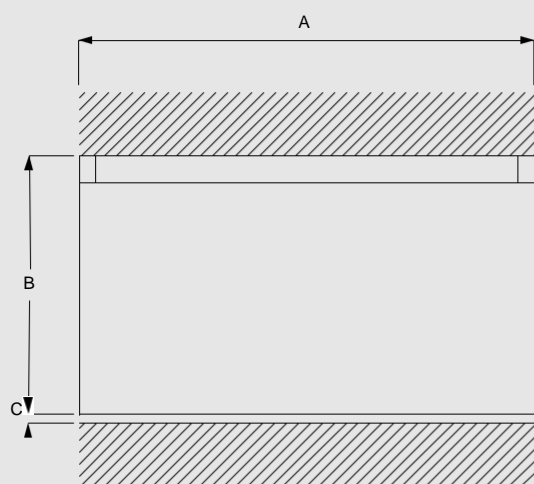

A: System width  
B: System height  
C: Distance between floor and fabric

1070

## Fitting Information

### Fixing Points

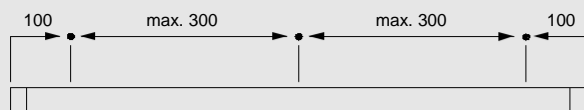



## Fitting Options

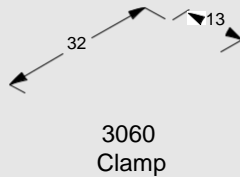
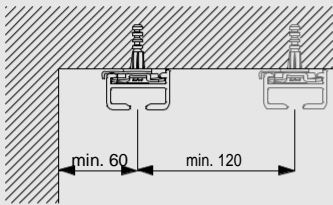











### Ceiling fitting with clamp 3060



## Standard Accessories

1071	Profile		1072	End cover	
3016	Endstop		3060	Clamp	
3534	Glider 3533 in strip form				

## Optional Accessories

3017	Endstop		3062	Connecting bridge	
3511	Glider		3548	Retrofit glider	
3570	Rotating glider		3582	Hook	
3599	Hook		10430	Draw rod with hook, 50cm	
10431	Draw rod with hook, 75cm		10432	Draw rod with hook, 100cm	
10433	Draw rod with hook, 125cm		10434	Draw rod with hook, 150cm	

1070



1070



[www.thehomeofinteriors.co.uk](http://www.thehomeofinteriors.co.uk)  
Email: [sales@thehomeofinteriors.co.uk](mailto:sales@thehomeofinteriors.co.uk)  
Tel: 01590 615775

[www.silentgliss.co.uk](http://www.silentgliss.co.uk)  
[www.silentglissglobal.com](http://www.silentglissglobal.com)

Silent Gliss Ltd  
Pyramid Business Park  
Poorhole Lane  
Broadstairs  
Kent  
CT10 2PT  
Great Britain

Tel: +44 (0) 1843 863571  
Fax: +44 (0) 1843 864503  
[info@silentgliss.co.uk](mailto:info@silentgliss.co.uk)

Silent Gliss Global Ltd  
Pyramid Business Park  
Poorhole Lane  
Broadstairs  
Kent  
CT10 2PT  
Great Britain

Tel: +44 (0) 1843 874250  
Fax: +44 (0) 1843 874457  
[info@silentglissglobal.com](mailto:info@silentglissglobal.com)