

# Hand Operated Curtain Track Systems



[www.thehomeofinteriors.co.uk](http://www.thehomeofinteriors.co.uk)

Email: [sales@thehomeofinteriors.co.uk](mailto:sales@thehomeofinteriors.co.uk)

Tel: 01625 449039

## Hand Operated Curtain Track System

# Silent Gliss® 1280

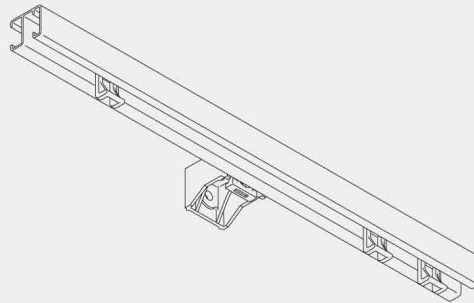

### Product Information

- Versatile hand operated curtain track system for contract and domestic applications
- For medium to heavy weight curtains
- Patented roller gliders glide on rim of front channel with very little friction for smooth and easy operation
- Standard profile colour: white
- Easy wall or ceiling fixing
- Available in 4m, 5m and 6m lengths
- Can be bent



1280

## Profile, Bending and Specification Information

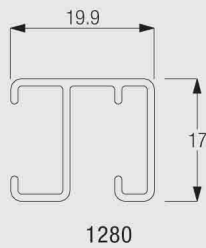

The standard radius is recommended for optimal operation. The minimum possible radius is 150mm.

**Specification Guide-** download from [www.silentgliss.co.uk](http://www.silentgliss.co.uk) (password required).

Silent Gliss 1280 hand drawn curtain track in white powder-coated aluminium. Use roller gliders 3922 at 10/m, fix to wall with brackets 3630/3660, ceiling with brackets 3603 every 300mm. Fit endcovers 3985.

## Fitting Information

### Bracket positioning and fixing with universal brackets 3603, 3630, 3655, 3660

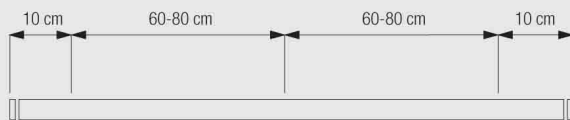

The fixing distances are meant as a guide only: they may vary in practice depending on the surface and curtain weight.

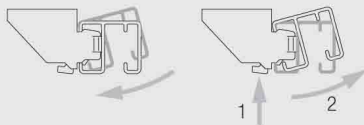

Installation: Roll track onto bracket in direction indicated  
Removal: 1. Press to release 2. Rotate forward for removal



1280

### Quick-clip glider 3933

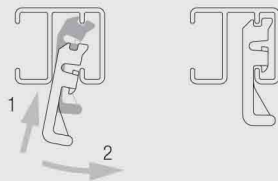

System 1280 is supplied with 3922 roller glider as standard, quick-clip glider 3933 is available as an optional accessory.

## Fitting Options

### Ceiling fix with bracket 3603

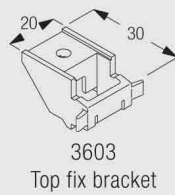
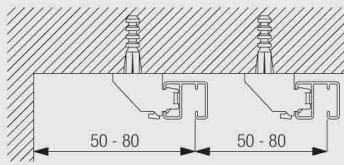

The final distances may be outside of the recommendations above depending on curtain heading, make-up and any obstructions.

### Wall fix with universal brackets 3630/3655/3660

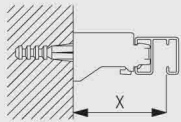

	X (mm)
3630	42
3655	57
3660	72

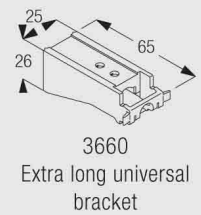
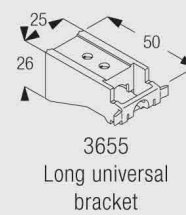
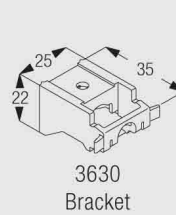

### Wall fitting with Smart Fix 11200-11204 and bracket 3603

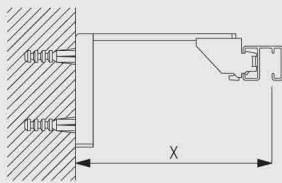

	X (mm)
11200	80
11201	100
11202	120
11203	140
11204	170

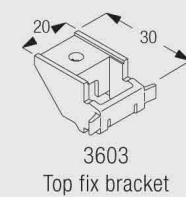
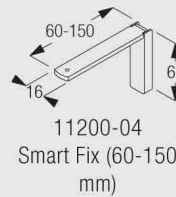

Brackets feature thread for screw SG 10492 (M4x8) for fixing bracket SG 3603.

### Wall fitting with Square Smart Fix 11210-11214 and bracket 3603

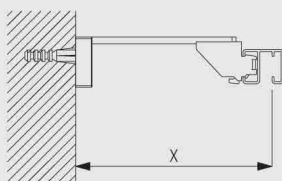

	X (mm)
11210	80
11211	100
11212	120
11213	140
11214	170

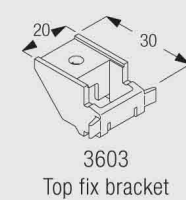
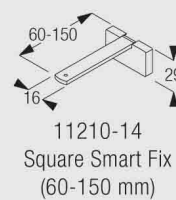

Brackets feature thread for screw SG 10492 (M4x8) for fixing bracket SG 3603.



1280

## Wall fitting with Universal Smart Fix 11154-11156 and bracket 3603

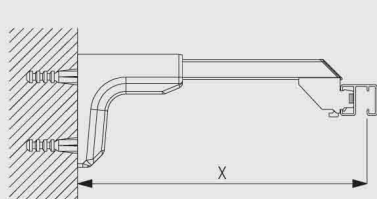

	X (mm)
11154	130-158
11155	160-188
11156	210-238

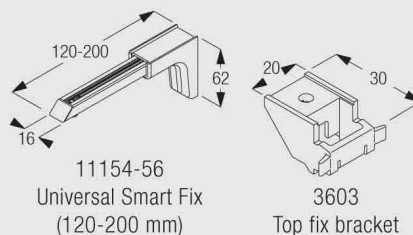

Brackets feature thread for screw SG 10277 (M4x12) for fixing bracket SG 3603.

### Standard Accessories

18R Screw 25mm. No. 8 roundhead

1280 Profile



3630 Bracket

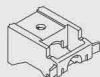

3922 Roller 3911 in strip form



3985 Endcover



### Optional Accessories

3603 Top fix bracket



3620 Connecting bridge

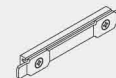

3660 Extra long universal bracket

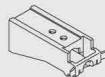

3932 Spring stop



3933 Glider 3933 in strip form



3942 Endstop



3975 Overlap arm for pulling by hand

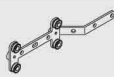

10430 Draw rod with hook, 50cm



10431 Draw rod with hook, 75cm



10432 Draw rod with hook, 100cm



10433 Draw rod with hook, 125cm



10434 Draw rod with hook, 150cm



11154 Universal Smart Fix, 120 mm set

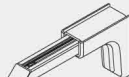

11155 Universal Smart Fix, 150 mm set

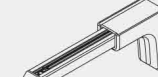

11156 Universal Smart Fix, 200 mm set

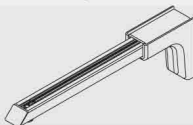

11200 Smart Fix, 60 mm set



11201 Smart Fix, 80 mm set



11202 Smart Fix, 100 mm set

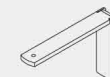

1280

11203	Smart Fix, 120 mm set		11204	Smart Fix, 150 mm set	
11210	Square Smart Fix, 60 mm set		11211	Square Smart Fix, 80 mm set	
11212	Square Smart Fix, 100 mm set		11213	Square Smart Fix, 120 mm set	
11214	Square Smart Fix, 150 mm set		3935A	Overlap arm straight with S-hook 3949	
3936A	Overlap arm with s-hook 3949				

### Useful Information and Sewing Accessories

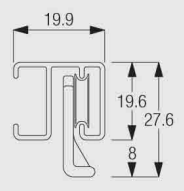
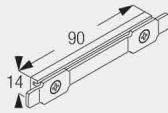

Diagram uses standard 3922 glider and is measured to the inside of the glider eye. For optional gliders substitute dimensions below:  
 3945/3946 = 8mm  
 3933 = 8mm

3562	Standard tape		3582	Hook	
3599	Hook				



### Useful Measurements

3620	Connecting bridge	
------	-------------------	---



[www.thehomeofinteriors.co.uk](http://www.thehomeofinteriors.co.uk)

Email: [sales@thehomeofinteriors.co.uk](mailto:sales@thehomeofinteriors.co.uk)

Tel: 01625 449039

[www.silentgliss.co.uk](http://www.silentgliss.co.uk)

[www.silentglissglobal.com](http://www.silentglissglobal.com)

Silent Gliss Ltd  
Pyramid Business Park  
Poorhole Lane  
Broadstairs  
Kent  
CT10 2PT  
Great Britain

Tel: +44 (0) 1843 863571  
Fax: +44 (0) 1843 864503  
[info@silentgliss.co.uk](mailto:info@silentgliss.co.uk)

Silent Gliss Global Ltd  
Pyramid Business Park  
Poorhole Lane  
Broadstairs  
Kent  
CT10 2PT  
Great Britain

Tel: +44 (0) 1843 874250  
Fax: +44 (0) 1843 874457  
[info@silentglissglobal.com](mailto:info@silentglissglobal.com)