

# Hand Operated Curtain Track Systems



[www.thehomeofinteriors.co.uk](http://www.thehomeofinteriors.co.uk)

Email: [sales@thehomeofinteriors.co.uk](mailto:sales@thehomeofinteriors.co.uk)

Tel: 01590 615775



## Hand Operated Curtain Track System

# Silent Gliss® 6970

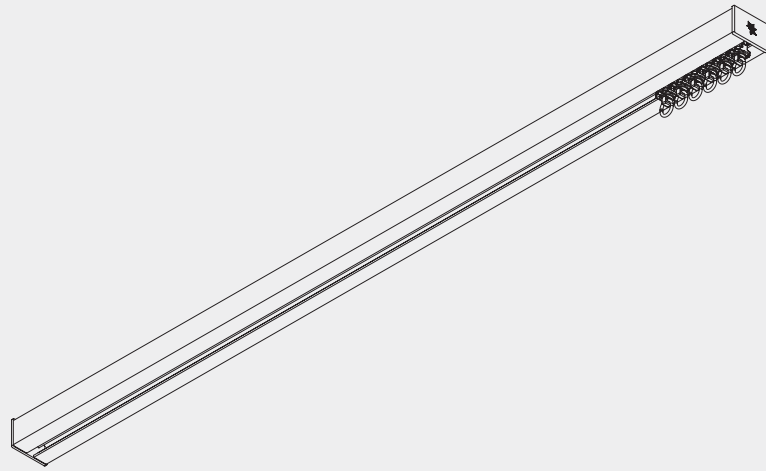

### Product Information

- Operation: hand drawn
- Range: L
- Fitting: ceiling, wall, recess
- Colours: white
- Shape: square
- 2C glider technology
- Wave compatible
- Bendable (including recess profile)



6970

## Profile and Bending Information

### Profile

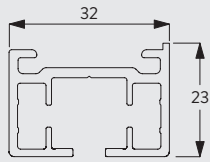

10850

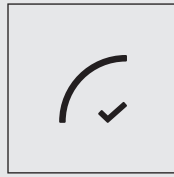

Radius: >25 cm

### Recess profile

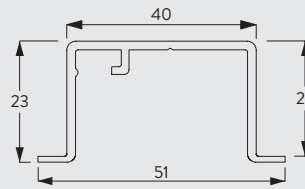

10862

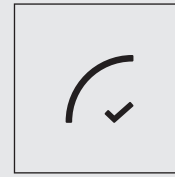

Radius: >50 cm  
Max. radius: 75 cm

## How To Measure

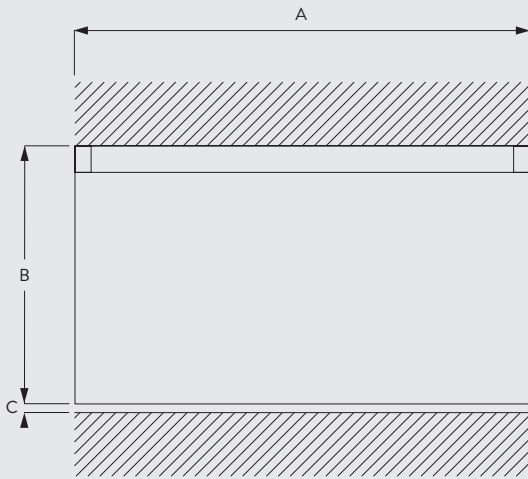

A: System width  
B: System height  
C: Distance between floor and fabric



## System Options

6970

### Wave Curtain Heading System

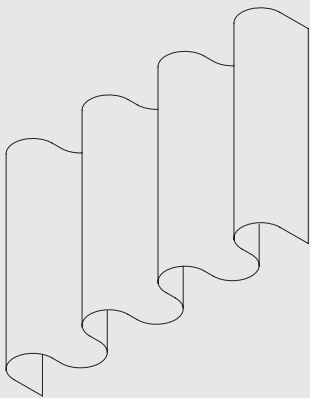

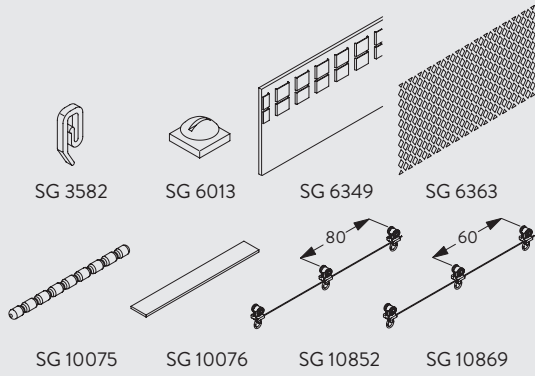

The Wave standard components are:

- 10869 Wave 2C Glider Cord 60mm
- 10852 Wave 2C Glider Cord 80mm
- 6007 End stop

Optional components to improve the presentation of the curtain:

- 3582 Hook
- 6349 Curtain tape
- 6363 Iron-on top hemming tape
- 10075 Lead weight for hem of curtain 50gr/m
- 10076 Fabric weight for side edge of curtain

## Fitting Information

### Fixing Points

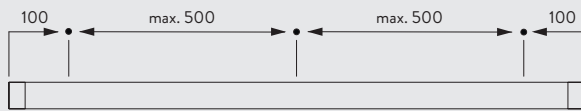

## Fitting Options

### Ceiling fitting with direct mounting

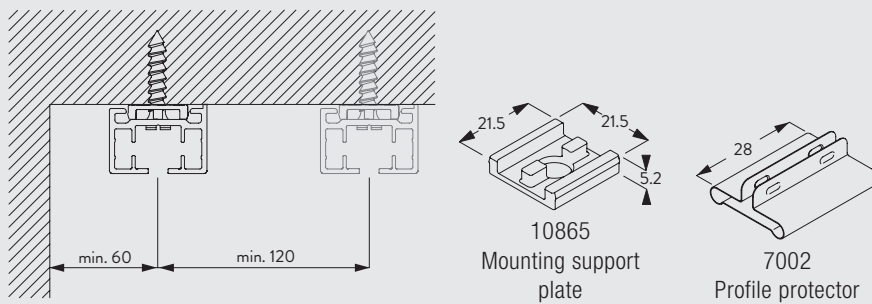

### Ceiling fitting with clamp SG 3004

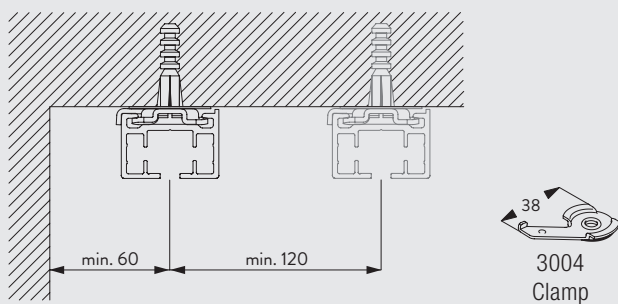

6970

Wall fitting with Smart Fix SG 11200-11205 and bracket SG 3041

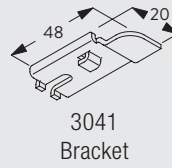
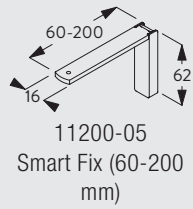
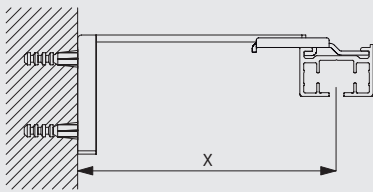

Brackets threaded for screw M4 x 8

Wall fitting with Square Smart Fix SG 11210-11215 and bracket SG 3041

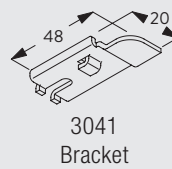
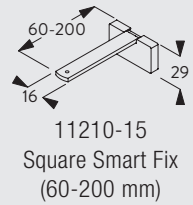
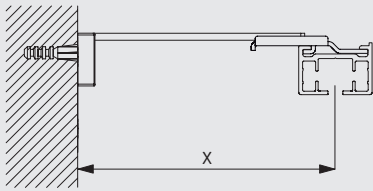

Brackets threaded for screw M4 x 8

Wall fitting with Universal Smart Fix SG 11154-11156 and bracket SG 3041

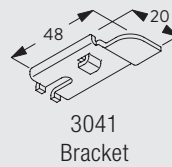
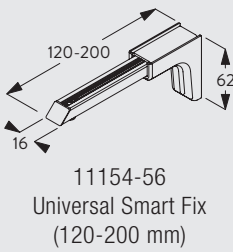
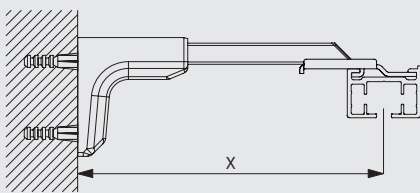

Brackets threaded for screw M4 x 8

6970

Wall fitting with Smart Fix SG 11201-11205 and clamp SG 3004

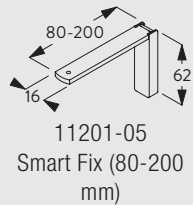
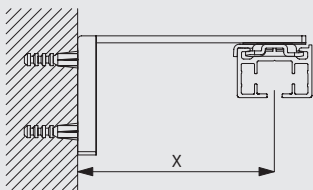

Brackets threaded for screw M4 x 8

### Wall fitting with Square Smart Fix SG 11211-11215 and clamp SG 3004

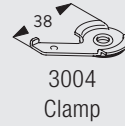
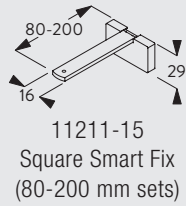
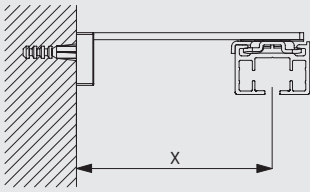

Brackets threaded for screw M4 x 8

### Wall fitting with Universal Smart Fix SG 11154-11156 and clamp SG 3004

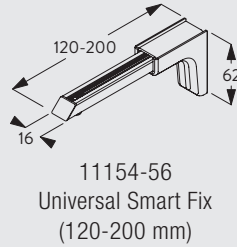
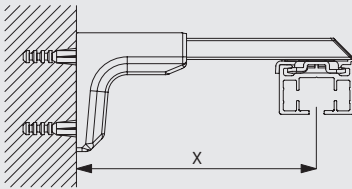

Brackets threaded for screw M4 x 8

### Recess fitting with recess profile SG 10862

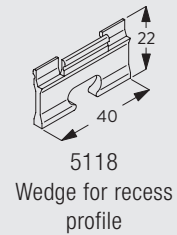
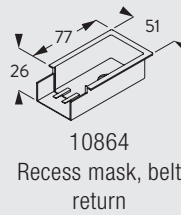
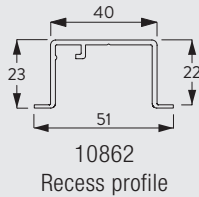
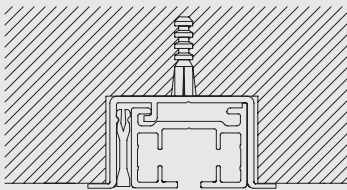

## Standard Accessories

3004 Clamp



6007 Endstop



10840 Two component roller



10850 Profile

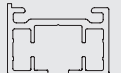

11235 End cover



## Optional Accessories

3582 Hook



5118 Wedge for recess profile









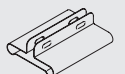





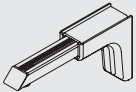
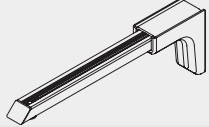

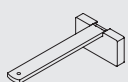
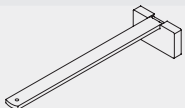

6007 Endstop



7002 Profile protector

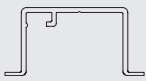
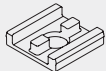
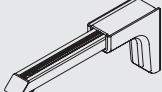

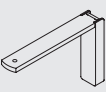
10407	Pan head screw M4x10	
10431	Draw rod with hook, 75cm	
10433	Draw rod with hook, 125cm	
10831	Connecting bridge	
10864	Recess mask, belt return	
11154	Universal Smart Fix, 120 mm set	
11156	Universal Smart Fix, 200 mm set	
11201	Smart Fix, 80 mm set	
11203	Smart Fix, 120 mm set	
11205	Smart Fix, 200 mm set	
11211	Square Smart Fix, 80 mm set	
11213	Square Smart Fix, 120 mm set	
11215	Square Smart Fix, 200 mm set	

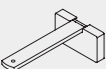
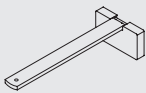
10430	Draw rod with hook, 50cm	
10432	Draw rod with hook, 100cm	
10434	Draw rod with hook, 150cm	
10862	Recess profile	
10865	Mounting support plate	
11155	Universal Smart Fix, 150 mm set	
11200	Smart Fix, 60 mm set	
11202	Smart Fix, 100 mm set	
11204	Smart Fix, 150 mm set	
11210	Square Smart Fix, 60 mm set	
11212	Square Smart Fix, 100 mm set	
11214	Square Smart Fix, 150 mm set	

6970

## Wave Accessories

6349	Curtain tape	
10075	Lead weight 50 gr/m	
10852	Wave roller cord (80mm), 6.5mm channel	

6363	Top hemming tape	
10076	Fabric weight	
10869	Wave roller cord (60mm), 6.5mm channel	





6970



6970



6970



[thehomeofinteriors.co.uk](http://thehomeofinteriors.co.uk)

The Design Hub  
41 Brookley Road  
Brockenhurst, Hampshire  
SO42 7RB  
[sales@thehomeofinteriors.co.uk](mailto:sales@thehomeofinteriors.co.uk)  
Tel: 01590 615775

[www.silentgliss.co.uk](http://www.silentgliss.co.uk)

[www.silentglissglobal.com](http://www.silentglissglobal.com)

Silent Gliss Ltd  
Pyramid Business Park  
Poorhole Lane  
Broadstairs  
Kent  
CT10 2PT  
Great Britain

Tel: +44 (0) 1843 863571  
Fax: +44 (0) 1843 864503  
[info@silentgliss.co.uk](mailto:info@silentgliss.co.uk)

Silent Gliss Global Ltd  
Pyramid Business Park  
Poorhole Lane  
Broadstairs  
Kent  
CT10 2PT  
Great Britain

Tel: +44 (0) 1843 874250  
Fax: +44 (0) 1843 874457  
[info@silentglissglobal.com](mailto:info@silentglissglobal.com)