

Installation and User Manual  
June 2019

EN

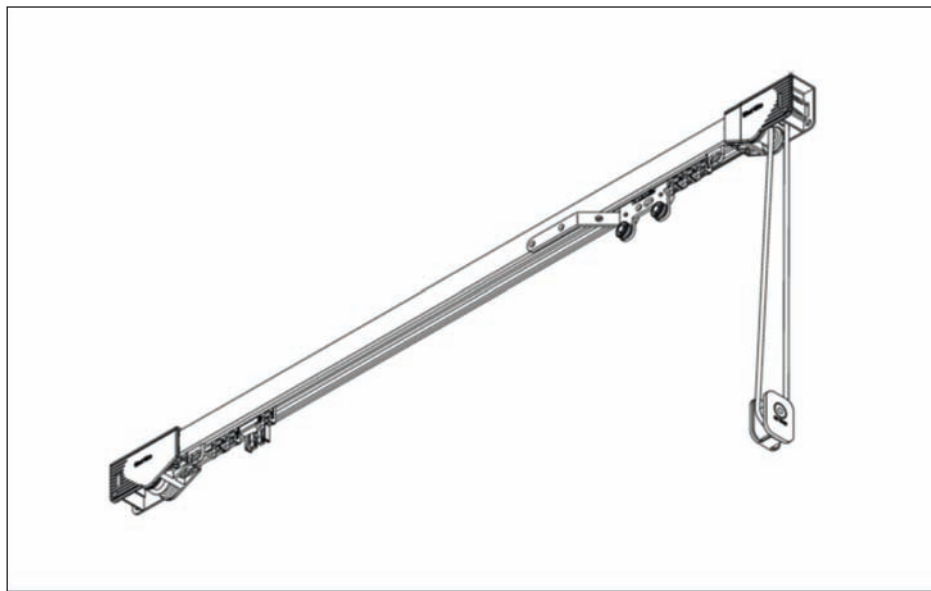

Cord operated curtain track systems  
SG 3000 / SG 3900

## Contents

General overview.....	3
Transportation, storage.....	3
Installation.....	4
Maintenance.....	4
EU Conformity.....	4
Ceiling Fitting.....	5
Wall Fitting.....	6
Faults and Troubleshooting.....	7

## 1 General Overview

### 1.1 User information

The Operating and Installation Instructions help to acquaint you with the product and its possible applications. They contain important tips to support the correct and safe operation of the product. Please retain a copy of this manual. It is to be read, understood and adhered to by each person who works with or on the system in the following tasks: installation, operation, maintenance and cleaning, troubleshooting.

This manual does not replace your **personal responsibility** as fitter or operator.

### 1.2 Intended use / Guarantee

The product is intended for use exclusively in accordance with these specifications and this manual, i.e. for: **Internal shading of windows (no outdoor installation)**.

A different use or use beyond this scope is not considered intended use. The manufacturer / supplier is not liable for any resulting damage. Non-compliance releases Silent Gliss from its liability.

The guarantee excludes faults that are not attributable to material or fabrication faults, but have arisen as a result of incorrect operation by the purchaser or improper care or other personal negligence. Troubleshooting measures falling outside of the guarantee will be carried out by Silent Gliss or another appropriate retailer at the cost of the purchaser.

### 1.3 Other applicable documents

Every product supplied includes documents that are a component part of the operating and installation instructions: *safety instructions, scale drawing, installation instructions*.

### 1.4 Safety instructions

The relevant safety laws in the country of operation must be adhered to. The following tips or symbols are used throughout:



**Warning - risk of injury!** Highlights possible hazards from mechanical workings which could lead to injury or even death.



**Use eye protection!** Eye protections must be worn during all drilling work.



**General warning sign!** Highlights general information.

The product may be installed only in a faultless condition (no transportation damage, etc.) and only as intended, in awareness of safety and hazards and in accordance with all tips in this manual.

Faults that could impair safety and functionality must be repaired.

The user (end customer) must have read and understood the operating instructions after installation and operational start-up are completed.

### 1.5 Maintenance, inspection and repair tips



Work must only be carried out by qualified specialists.

## 2 Transportation, Storage

### 2.1 Transportation



The product may be transported only in suitable and sufficient protective packaging (manufacturer's packaging). Curved products (rails, etc.) require wooden crating.

Waste and packaging material is to be disposed of in line with local regulations.

Keep packaging material out of the reach of children. Packing sheets, Styrofoam pieces and other small parts can be dangerous for children to play with.

### 2.2 Storage



Products and their accessories are to be stored in suitable packaging in dust-free spaces with normal humidity.

### 3 Installation

#### 3.1 Installation instructions, aids and personal protection



Local safety regulations must be observed during installation of the product (stable ladders, etc.).



#### **Warning! (if applicable)**

Young children can be strangled by loops in pull cords, chains, tapes and inner cords that operate the product.



To avoid strangulation and entanglement, keep cords out of the reach of young children. Cords may become wrapped around a child's neck. Move beds, cots and furniture away from window covering cords. Do not tie cords together. Make sure cords do not twist and create a loop.

#### 3.2 Motorisation



Electrical installation must be carried out by a certified electrician in accordance with the legal regulations and standards of the relevant country.

#### 3.3 Unpacking



Unpack components carefully

Waste and packaging material is to be disposed of in line with local regulations. Keep packaging material out of the reach of children. Packing sheets, Styrofoam pieces and other small parts can be dangerous for children to play with. Check delivery items against delivery note.

#### 3.4 System handling



Please note the following during unpacking and installation: a) do not cause contamination from unwashed hands.

b) do not allow moisture to get on the fabric. c) avoid causing kinks and snags (e.g. by dragging over surfaces and edges).

#### 3.5 Overhead and wall installation



During installation, window handles and other protruding items and fittings must not impair the function of the product. The fixing material should be chosen to suit the background. The fitter is responsible for selecting the correct fixing materials.

**Check:** Raise and lower blind and check correct winding and square hanging of the fabric.

### 4 Maintenance

#### 4.1 Repairs / Inspection



Any repair work required by the system may only be carried out by authorised specialists.

Only original replacement parts may be used for repairs.

#### 4.2 Cleaning



The product and its components, such as mouldings end caps, etc., must not be treated with aggressive cleaning products. It is best cleaned with a slightly damp cloth.

For heavier soiling, warm water with a neutral, non-abrasive cleaning product (pH-neutral domestic washing-up liquid) may be used.

#### 4.3 Care hints for fabrics



Washable!



Do not tumble dry



Do not iron!



Do not dry clean!



Do not bleach!

#### 4.4 Disposal



The product must be disposed of in line with local waste disposal regulations for industrial waste.

### 5 EU Conformity

EU conformity has been certified. This documentation can be requested from Silent Gliss.

## 6 Installation

- 6.1 Ceiling installation  
 6.1.1 SG 3000 / SG 3900

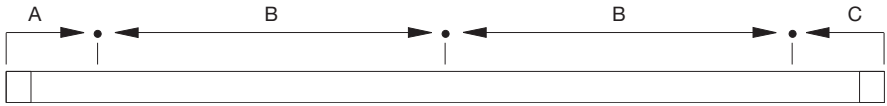

System	A (mm)	B (mm)	C (mm)
SG 3000	150	Max. 600	150
SG 3900	100	Max. 600	100

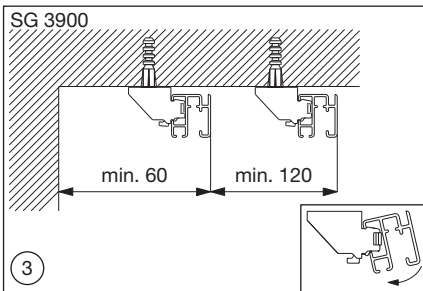
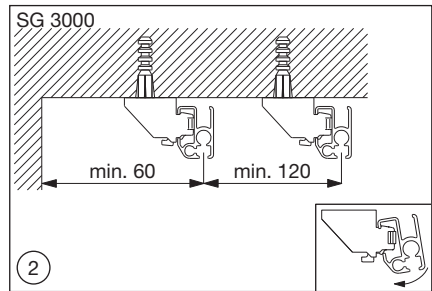
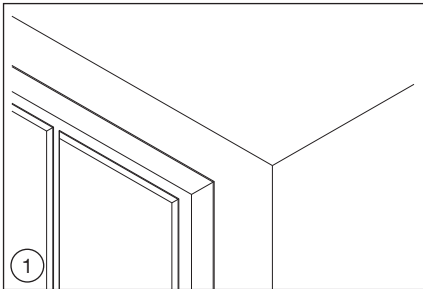

6.2 Wall installation  
 6.2.1 SG 3000 / SG 3900

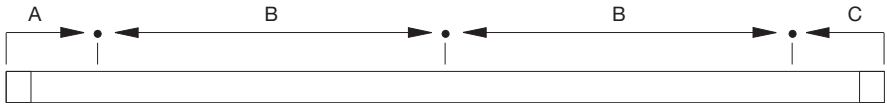

System	A (mm)	B (mm)	C (mm)
SG 3000	150	Max. 600	150
SG 3900	100	Max. 600	100

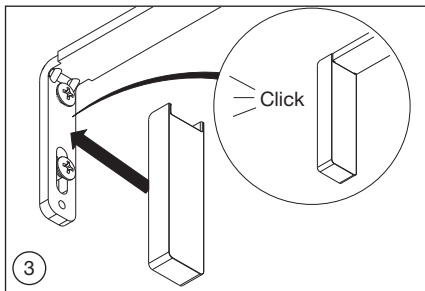
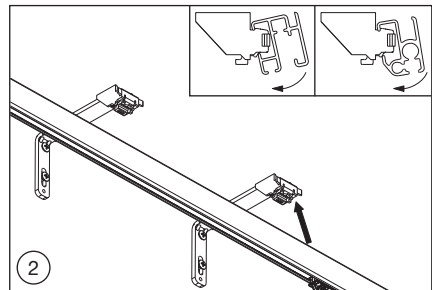
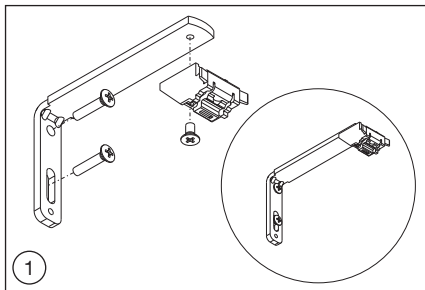

## 7 Faults and Troubleshooting

Possible fault	Possible cause	Elimination of the fault
Curtain is difficult to move	Profile was not siliconized	Siliconize profile
The profile is bent	Curtain weight is too heavy or the number of clamps is not sufficient	Fit additional clamps or take a larger profile
System has fallen down	Curtain weight is too heavy or the number of clamps is not sufficient	Fit additional clamps or take a larger profile
Cord is torn	Curtain weight is too heavy or pilot runner has not been properly mounted and tightened	Mount pilot runner correctly on string and tighten

[www.silentgliss.co.uk](http://www.silentgliss.co.uk)