

SG 1090

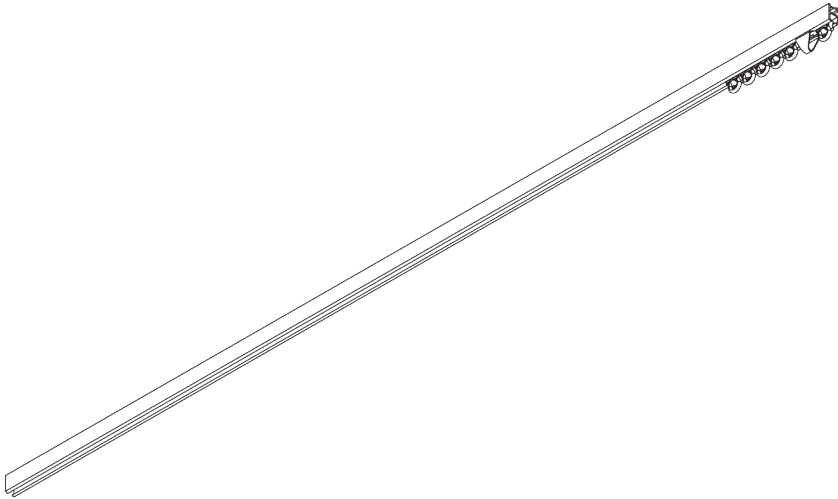

PRODUCT INFORMATION

- **Operation:** hand
- **Range:** S
- **Fitting:** ceiling, wall
- **Colours:** white RAL 9016; special colours or anodised aluminum possible
- **Fabrics:** refer to Silent Gliss fabric collection

Features:

- Bendable

SYSTEM SPECIFICATIONS

A. PROFILE

Profile and bending information

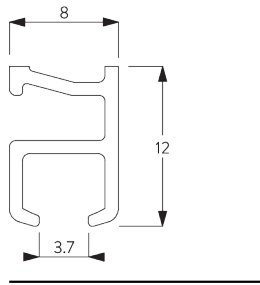

SG 1090p

Profile

Radius:
✓ 6 cm, 10 cm

B. HOW TO MEASURE

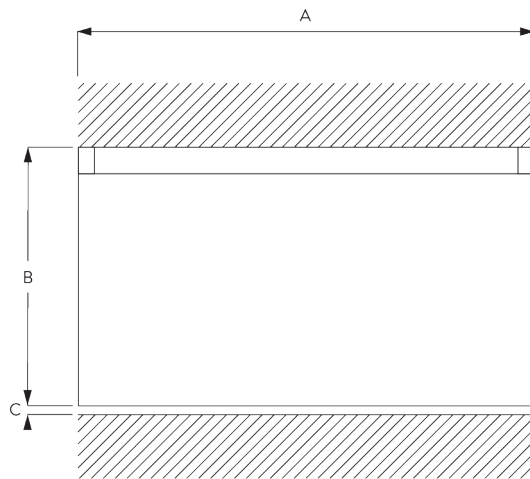

A: System width

B: System height

C: Distance between floor and fabric

C. SPECIFICATION

TEXT

Silent Gliss SG 1090 Hand Operated Curtain Track System. Comprises aluminium profile SG 1090 supplied made to measure in silver anodised or powder coated white, with gliders SG 3533 at 14/m and 2 end stops SG 3016 per length. Face fixed with nylon brackets SG 3175 / SG Smart Fix / top fixed with nylon bracket SG 3176 at max. 400 mm centres.

FITTING

A. FITTING INFORMATION

Fixing points

For detailed fitting information, visit the [Silent Gliss website](#).

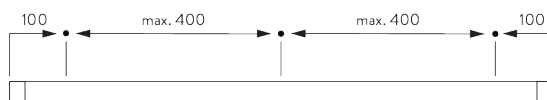

B. CEILING FITTING

Bracket SG 3176

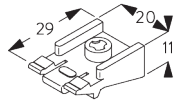
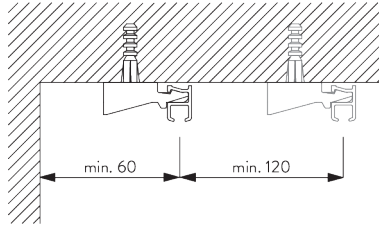

SG 3176
Bracket

Double ceiling bracket SG 3113 / SG 3115

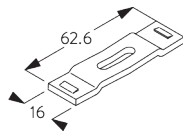
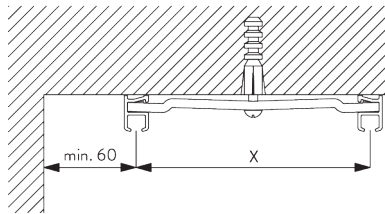

SG 3113
Bracket

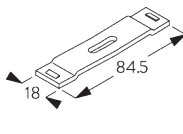

SG 3115
Bracket

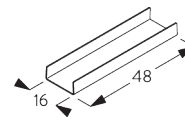

SG 3255
Cover

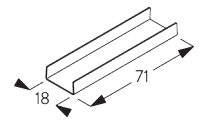

SG 3256
Cover

Bracket	X mm
SG 3113	57
SG 3115	80

C. WALL FITTING

Bracket SG 3175

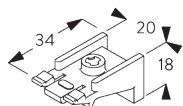
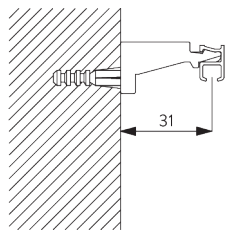

SG 3175
Bracket

Smart Fix

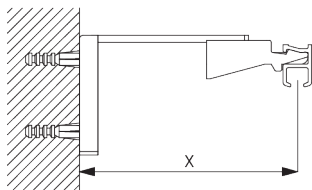

Smart Fix SG 11200 - SG 11205 and bracket SG 3176:
Screw SG 10277 (M4x12) needed.

Smart Fix	X mm
SG 11200 / SG 11210	68
SG 11201 / SG 11211	88
SG 11202 / SG 11212	108
SG 11203 / SG 11213	128
SG 11204 / SG 11214	158
SG 11205 / SG 11215	208

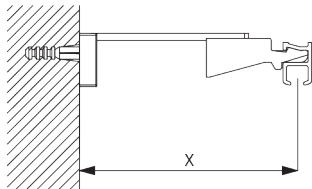

Square Smart Fix SG 11210 - SG 11215 and bracket SG 3176:
Screw SG 10277 (M4x12) needed.

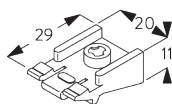

SG 3176
Bracket



SG 10277
Pan head screw M4x12

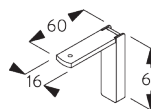

SG 11200
Smart Fix 60 mm

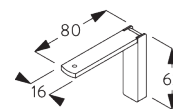

SG 11201
Smart Fix 80 mm

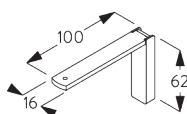

SG 11202
Smart Fix 100 mm

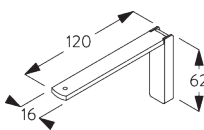

SG 11203
Smart Fix 120 mm

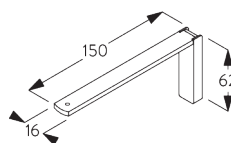

SG 11204
Smart Fix 150 mm

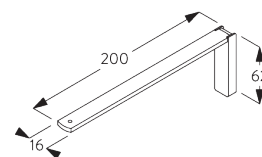

SG 11205
Smart Fix 200 mm

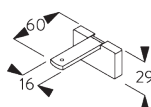

SG 11210
Square Smart Fix 60 mm

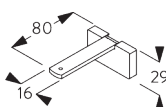

SG 11211
Square Smart Fix 80 mm

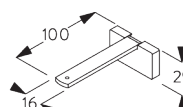

SG 11212
Square Smart Fix 100 mm

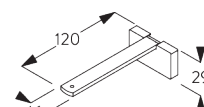

SG 11213
Square Smart Fix 120 mm

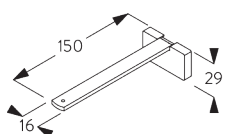

SG 11214
Square Smart Fix 150 mm

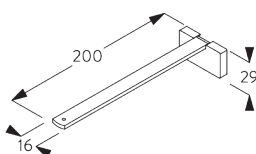

SG 11215
Square Smart Fix 200 mm

GENERAL NOTES

Dimensions

- Measurements are in mm except where indicated.
- Max. kg relates to fabric incl. accessories.
- Stack size depends on curtain make-up and fabric thickness.
- Distance between gliders max. 80 mm / distance between rollers max. 100 mm.
- Recommended distance floor / fabric: 20 mm.
- In order to determine system height (B), the smallest room height must be taken into account.

Fitting





- Installation by qualified fitter only.
- Number of brackets and fitting positions / fixing points vary depending on fitting surface, system weight, fabric make-up, screw / fixing type and obstacles.
- Qualified fitter must use appropriate screws / fixings for each situation.
- Profile lip if applicable to be installed to room side.

Child Safety



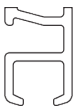







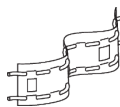



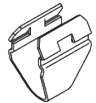

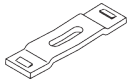

- All relevant Silent Gliss systems correspond to child safety EN 13120.
- All parties involved must comply with EN 13120.

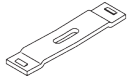
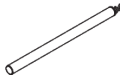
PARTS

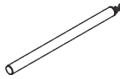
A. STANDARD PARTS

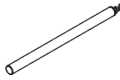
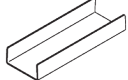
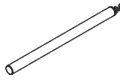
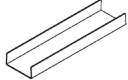
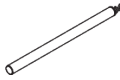
	SG 1090p Profile
	SG 3016 End stop
	SG 3175 Bracket
	SG 3533 Glider

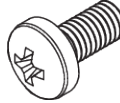
B. OPTIONAL PARTS

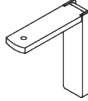
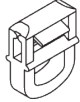
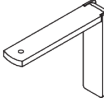
	SG 3020 Hook		SG 3562 Heading tape
	SG 3032 Spring stop		SG 3570 Glider
	SG 3071 End stop		SG 3571 Hook
	SG 3085 Spring stop		SG 3582 Hook
	SG 3096 Connection bridge		SG 3599 Hook
	SG 3113 Bracket		SG 10277 Pan head screw M4x12
	SG 3115 Bracket		SG 10430 Draw rod 50 cm
	SG 3151 Spacer		SG 10431 Draw rod 75 cm
	SG 3176 Bracket		SG 10432 Draw rod 100 cm
	SG 3255 Cover		SG 10433 Draw rod 125 cm
	SG 3256 Cover		SG 10434 Draw rod 150 cm
	SG 3511 Glider		SG 10492 Pan head screw M4x8
	SG 3534 Glider 3533 on strip		SG 11200 Smart Fix 60 mm
	SG 3548 Glider		SG 11201 Smart Fix 80 mm

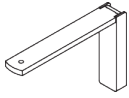

SG 11202
Smart Fix 100 mm

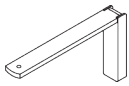

SG 11203
Smart Fix 120 mm

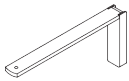

SG 11204
Smart Fix 150 mm

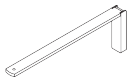

SG 11205
Smart Fix 200 mm

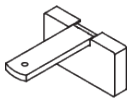

SG 11210
Square Smart Fix 60 mm

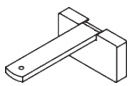

SG 11211
Square Smart Fix 80 mm

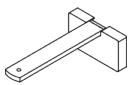

SG 11212
Square Smart Fix 100 mm

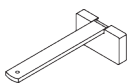

SG 11213
Square Smart Fix 120 mm

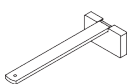

SG 11214
Square Smart Fix 150 mm

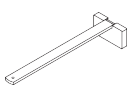

SG 11215
Square Smart Fix 200 mm

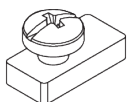

SG 11335
End stop
