

Decorative Curtain Poles



www.thehomeofinteriors.co.uk

Email: sales@thehomeofinteriors.co.uk

Tel: 01590 615775



Hand Operated Curtain Pole System

Silent Gliss® 6140M Metropole 50mm

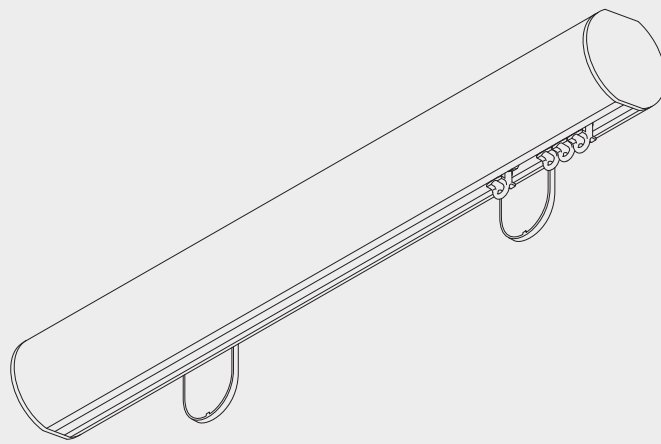

Product Information

- Hand operated system for domestic and contract applications
- Can be bent for bay windows
- Choice of 9 different finishes - black, white, matt white, ecru, slate grey, antique bronze, silver, anodic grey and taupe
- Accessorised with matching end caps brackets
- A selection of finials are available
- Easy wall or ceiling fix
- For medium to heavy curtains
- Suitable for use with Wave curtain heading system

6140M

Profile and Bending Information

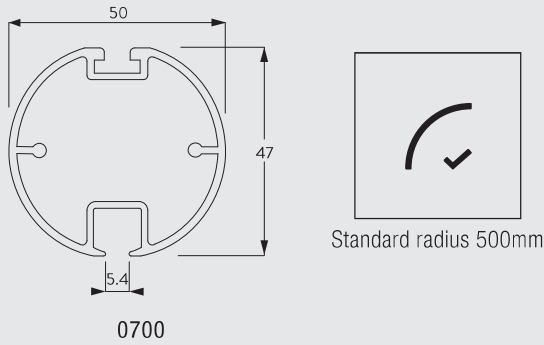

Specification Guide - download www.silentgliss.co.uk (password required)

Silent Gliss 6140M curtain track, hand drawn, aluminium, assembled complete with gliders 6143 at 10/m and 2 endcovers 0350. Face fix with brackets 11206-208/11216-218/11209/0334/ceiling fix with bracket 6138P2/0335 each screwed to timber /plugged and screwed to block-work/concrete at 600mm centres. Finished in black, white, matt white, ecru, slate grey, antique bronze, taupe, silver, anodic grey or taupe.

How To Measure

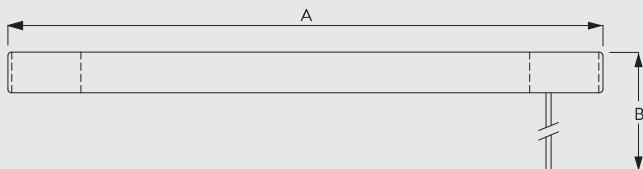

A: System Width - includes finials. See 'Design Options' for finial sizes.

Stack Size Calculation Wave Standard

6140M

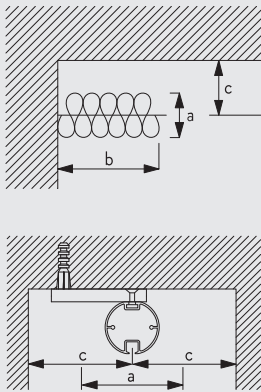

a = Stack depth
b = Stack size
c = Min. distance

Glider-cord spacing	Curtain hook spacing	Approx. curtain fullness	Stack depth (a)	Stack width (b)	Min distance (c)
6	10	2.1	10	23 per metre of track + endpiece	8
6	12	2.3	12	23 per metre of track + endpiece	9
8	14	2.1	14	18 per metre of track + endpiece	10
8	16	2.3	16	18 per metre of track + endpiece	11

Wave standard with roller gliders

Glider-cord spacing	Curtain hook spacing	Approx. curtain fullness	Stack depth (a)	Stack width (b)	Min distance (c)
8	14	2.1	14	21 per metre of track + endpiece	10
8	16	2.3	16	21 per metre of track + endpiece	11

(dimensions in cm)

Note: Minimum distance (c) includes a standard 3cm clearance (front and back).

Design Options

Endcaps

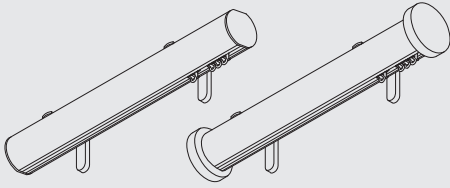

Without finials, poles are supplied as standard with flush fitting endcaps 0350 (left). Alternatively, stud endcaps 0714 (right) can be selected at no additional cost.

Finials

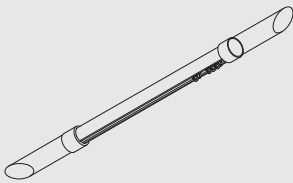

Finials are decorative elements that fit on at the end of the pole.

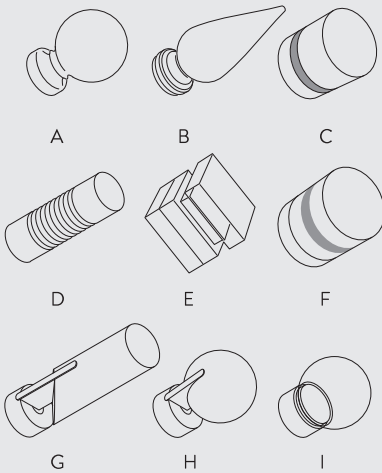

- A: 0717 Ball End 125mm
- B: 0718 Real Wood Spear 150mm
- C: 0697 Strata 65mm
- D: 0630 Groove Cylinder 125mm
- E: 0898 Crystal Cube 55mm
- F: 0899 Crystal Cylinder 55mm
- G: Fused Barrel 121mm (walnut/oak/matched)
- H: Fused Ball 81mm (walnut/oak/matched)
- I: Glass Ball (clear/frosted) 70mm

6140M

Wave Standard curtain heading system

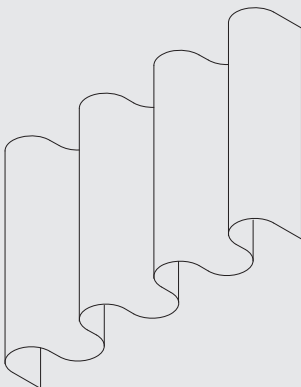

Wave is an exciting contemporary curtain heading system which allows curtains to hang in a continuous wave which is smooth, simple and elegant.

When using the Wave curtain heading system please note the maximum recommended curtain weight is 2.5kg/m or 10kg/m with wave roller gliders 6098W.

The Wave standard components are:

- 6345 Glider Cord 60mm
- 6346 Glider Cord 80mm
- 6007 End stop

The items listed below for Enhanced Wave (80mm glider cord only) are all supplied at an additional cost as per the price list.

- 2255 Adjustable brake
- 6364 Extension (for use with 6365)
- 6365 Hanger (for use with 6364)
- 6366 Carrier for draw rod

Roller gliders must be ordered separately
6098W Wave roller glider 80mm

Optional enhanced components to improve the presentation of the curtain:

- 3582 Hook
- 6349 Curtain tape
- 6363 Iron-on top hemming tape
- 10075 Lead weight for bottom hem 50gr/m
- 10076 Fabric weight for side of curtain

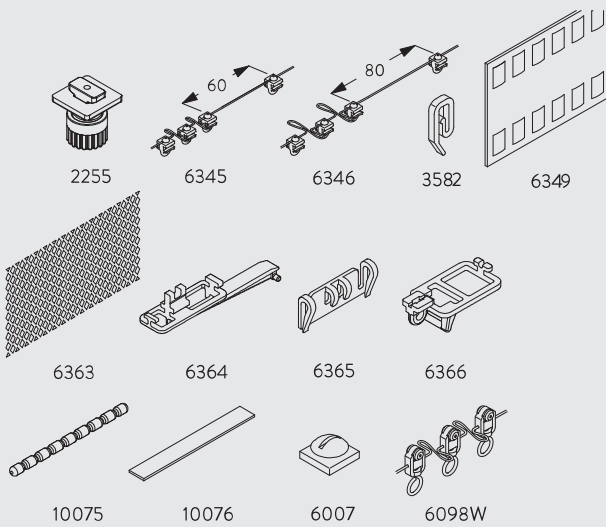

Connecting Profiles

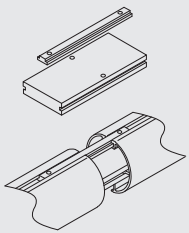

Profiles can be joined with Connecting Bridge 0273.

6140M

Fitting Information

Bracket positioning

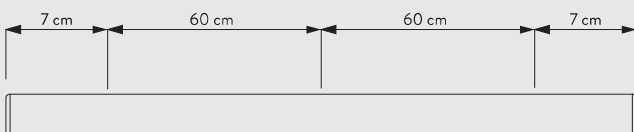

Fitting of track to bracket

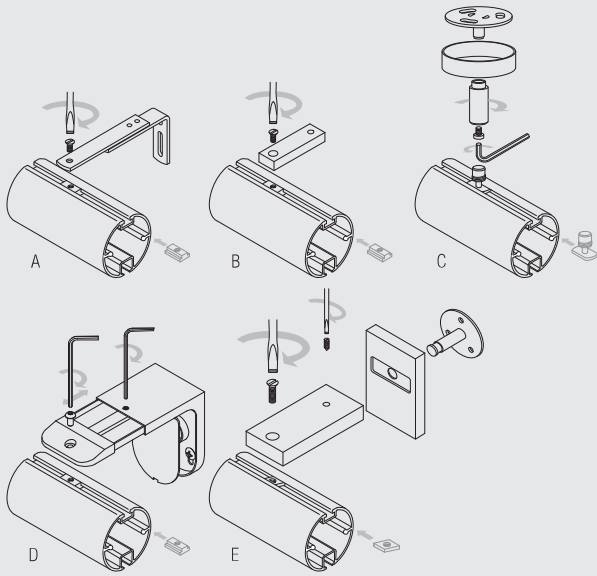

- A: Using adjustable bracket set 11209
- B: Using ceiling fix bracket 6138p
- C: Using top fix bracket 0335
- D: Using maxi adjustable bracket 0334
- E: Using blok bracket 0989

All 50mm Metropole are supplied with Maxi bracket 0334 as standard unless otherwise specified.

Fitting Options

Wall fix with Smart Fix adjustable brackets 11209

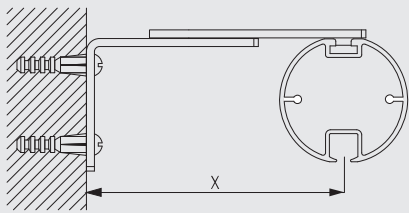

	X (mm)
11209	80-100

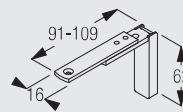

11209
Smart Fix with
extension arm set

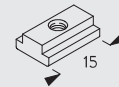

6141
Track insert (uses
screw 0798)

Ceiling fix with 6138P2

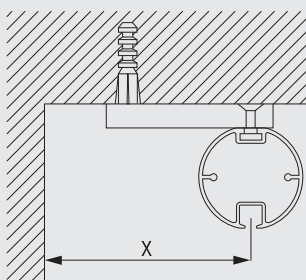

	X (mm)
6138P2	80

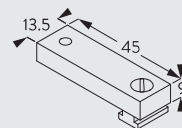

6138P2
Ceiling support set
(9mm)

6140M

Ceiling fix with top fix bracket 0335

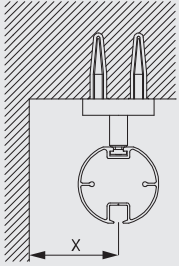

X (mm)
50

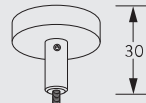

0335
Top fix bracket

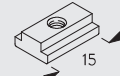

6141
Track insert (uses
screw 0798)

Wall fix with maxi adjustable bracket 0334

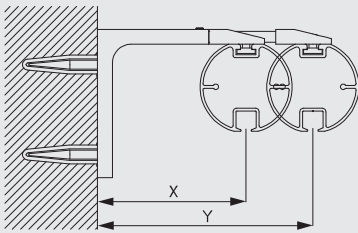

	X (mm)	Y (mm)
0334	80	100

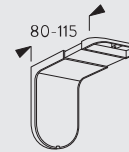

0334
Maxi adjustable
bracket

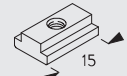

6141
Track insert (uses
screw 0798)

Wall fitting with Smart Fix with slot 11206-11208

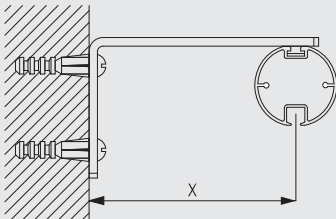

	X (mm)
11206	33-51
11207	53-71
11208	73-91

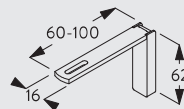

11206-08
Smart Fix with slot
(60-100 mm)

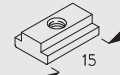

6141
Track insert (uses
screw 0798)

Wall fitting with Square Smart Fix with slot 11216-11218

6140M

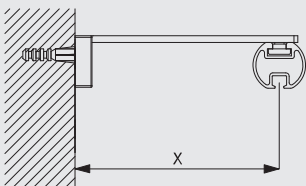

	X (mm)
11216	33-51
11217	53-71
11218	73-91

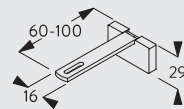

11216-18
Square Smart Fix
with slot (60-100
mm)

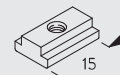

6141
Track insert (uses
screw 0798)

Wall fitting with Blok bracket 0989

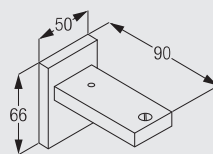
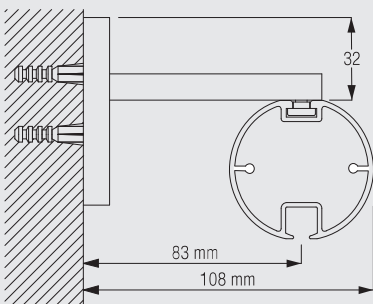

0989
Blok Bracket

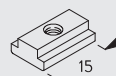

6141
Track insert (uses
screw 0798)

Standard Accessories

Parts

0334 Maxi adjustable bracket



0700 Profile 50mm



6141 Track insert (uses screw 0798)



6784 Machine screw (for 6141 insert)

0350 Flush endcap (50mm)



6065 Twist eye endstop



6143 Glider 6144 in strip form



Optional Accessories

Parts

0273 Connecting Bridge for System 6140



0327 Fused ball (50mm)



0335 Top fix bracket



0697 Strata (50mm)



0717 Ball end finial (50mm pole)



0898 Crystal Square (50mm)



0989 Blok Bracket



11206 Smart Fix, 60 mm with slot set



11208 Smart Fix, 100 mm with slot set

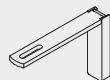

11216 Square Smart Fix, 60 mm with slot set



11218 Square Smart Fix, 100 mm with slot set

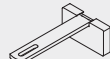

0315 Fused barrel (50mm)

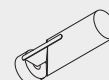

0333 Glass ball (50mm)



0630 Groove Cylinder (50mm)



0714 Stud End cap (50mm)



0718 Spear finial (50mm pole)



0899 Crystal Cylinder (50mm)



6283 Roller glider



11207 Smart Fix, 80 mm with slot set



11209 Smart Fix with extension arm set

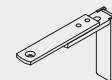

11217 Square Smart Fix, 80 mm with slot set





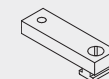







6138P2 Ceiling support set (9mm)

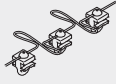

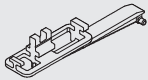
6140M

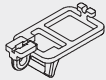
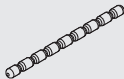
Wave Accessories

2255	Adjustable brake		3582	Hook	
6007	Endstop		6345	Wave glider cord (60mm)	
6346	Wave glider cord (80mm)		6349	Curtain tape	
6363	Top hemming tape		6364	Extension	
6365	Hanger		6366	Wave carrier for draw rod	
10075	Lead weight 50 gr/m		10076	Fabric weight	
6098W	Wave roller glider cord (80mm)				

6140M



thehomeofinteriors.co.uk

The Design Hub
41 Brookley Road
Brockenhurst, Hampshire
SO42 7RB
sales@thehomeofinteriors.co.uk
Tel: 01590 615775

www.silentgliss.co.uk

www.silentglissglobal.com

Silent Gliss Ltd
Pyramid Business Park
Poorhole Lane
Broadstairs
Kent
CT10 2PT
Great Britain

Tel: +44 (0) 1843 863571
Fax: +44 (0) 1843 864503
info@silentgliss.co.uk

Silent Gliss Global Ltd
Pyramid Business Park
Poorhole Lane
Broadstairs
Kent
CT10 2PT
Great Britain

Tel: +44 (0) 1843 874250
Fax: +44 (0) 1843 874457
info@silentglissglobal.com