

Decorative Curtain Poles



www.thehomeofinteriors.co.uk

Email: sales@thehomeofinteriors.co.uk

Tel: 01590 615775



Cord Operated Curtain Pole System

Silent Gliss® 6120M Metropole 30mm

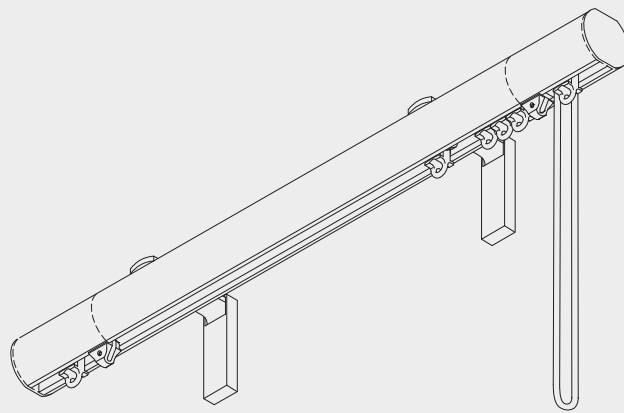

Product Information

- Cord operated system for domestic and contract applications
- 6120 can be bent to a small radius for bay windows etc
- For light to medium weight curtains
- Made to measure
- Profile length 6m (chrome effect 4m)
- Choice of 14 different finishes - ecru, bronze, antique bronze, chrome effect, gunmetal, black, white, matt white, anodic grey, slate grey, sand, taupe, charcoal and ochre
- Wide range of finials in contemporary or traditional styles
- Easy wall or ceiling fix
- Suitable for use with Wave Standard curtain heading system

6120M

Profile, Bending and Specification Information

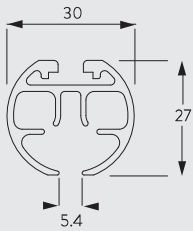

6106

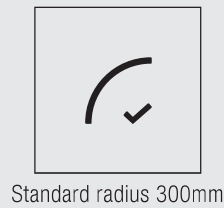

Standard radius 300mm

Specification Information - for download refer to www.silentgliss.co.uk (password required).

Silent Gliss 6120 curtain track, cord drawn, aluminium, assembled complete with gliders 6143 at 10/m. Metal overlap arm 6063, pulley set cord set 0340, end caps 0346, cord 3091, pilot 6534 and endstops 6065. Face fix with bracket 11206-11208/11216-11218/11209/0674/0334/ top fix with bracket 0335/6138P2/ 6138P6 each screwed to timber/plugged and screwed to block/concrete at 600mm centres. Finished in ecru, bronze, antique bronze, chrome effect, gunmetal, black, white, matt white, anodic grey, slate grey, sand, taupe, charcoal or ochre.

How To Measure

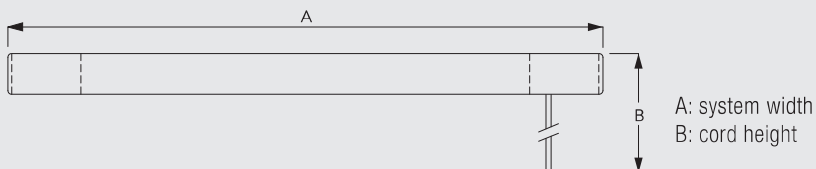

A: system width
B: cord height

Stack Size Calculation Wave Standard

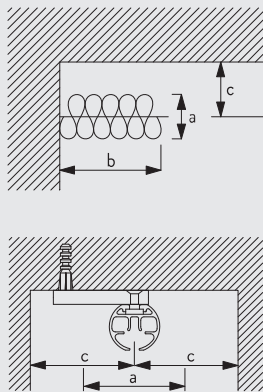

a = Stack depth
b = Stack size
c = Min. distance

Glider-cord spacing	Curtain hook spacing	Approx. curtain fullness	Stack depth (a)	Stack width (b)	Min distance (c)
6	10	2.1	10	23 per metre of track + endpiece	8
6	12	2.3	12	23 per metre of track + endpiece	9
8	14	2.1	14	18 per metre of track + endpiece	10
8	16	2.3	16	18 per metre of track + endpiece	11

Wave standard with roller gliders

Glider-cord spacing	Curtain hook spacing	Approx. curtain fullness	Stack depth (a)	Stack width (b)	Min distance (c)
8	14	2.1	14	21 per metre of track + endpiece	10
8	16	2.3	16	21 per metre of track + endpiece	11

(dimensions in cm)

Note: Minimum distance (c) allows a standard 3cm clearance (front and back).

System Dimensions

Maximum curtain weights

	Standard Application with Glider						Standard Application with Roller/ Wave Roller					
	1 m	2 m	3 m	4 m	5 m	6 m	1 m	2 m	3 m	4 m	5 m	6 m
	9	9	8	8	7	7	12	11	11	11	10	10
	10	10	9	9	8	8	13	13	12	11	11	10
	7	7	6	6	5	5	9	8	8	8	7	7
	8	8	7	7	6	6	10	9	9	9	8	8
	4	4	3	3	2	2	6	5	5	5	4	4
	5	5	4	4	3	3	7	6	6	6	5	5
	3	3	2	2	1	1	5	4	4	4	3	3
	4	4	3	3	2	2	6	5	5	5	4	4

(kg max.)

Wave maximum curtain weights

Maximum curtain weight when using Wave curtain heading is 2.5kg/m unless the weight in above table is less in which case follow table. A greater weight may be achieved using wave roller glider 6098W (refer to table above right).

Design Options

Endcaps

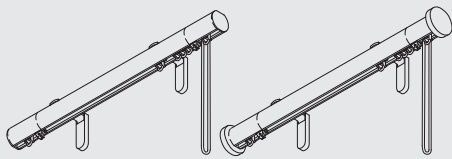

Without finials, poles are supplied as standard with flush fitting endcaps 0346 (left). Alternatively, stud endcaps 0707 (right) can be selected at no additional cost.

Finials

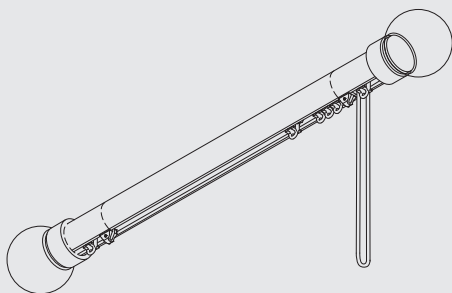

Finials are decorative elements that fit on the end of the pole.

6120M

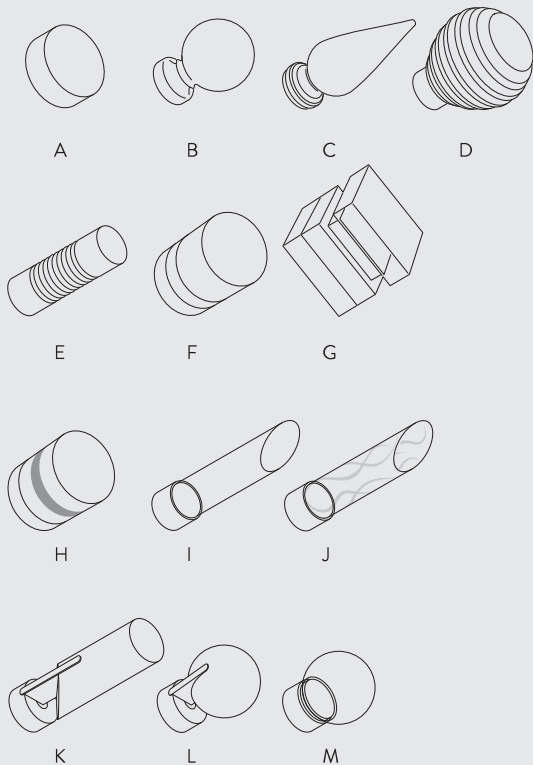

- A: 0873 Design Endcap 20mm
- B: 0556 Ball End 70mm
- C: 0719 Spear 135mm
- D: 0986 Groove Ball 85mm
- E: 0629 Groove Cylinder 85mm
- F: 0901 Strata 65mm
- G: 0886 Crystal Cube 55mm
- H: 0896 Crystal Cylinder 55mm
- I: 0995CL Shard Clear 127mm
- J: 0995ET Shard Etched 127mm
- K: 0311 Fused Barrel 102mm (walnut/oak/matched)
- L: 0324 Fused Ball 60mm (walnut/oak/matched)
- M: 0331 Glass Ball (clear/frosted) 55mm

Wave Standard curtain heading system

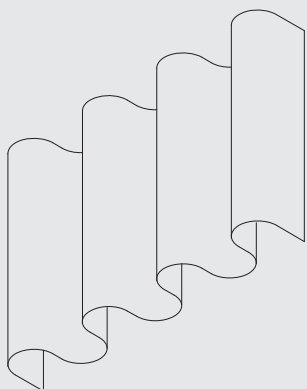

Wave Standard is an exciting new contemporary curtain heading system which allows curtains to hang in a continuous wave which is smooth, simple and elegant.

When using the Wave curtain heading system please note the maximum recommended curtain weight is 2,5kg/m. A greater weight may be achieved using wave roller glider 6098W (refer to System Dimensions).

6120M

The Wave standard components are:

- 6345 Glider Cord 60mm
- 6346 Glider Cord 80mm
- 6007 End stop

The items listed below for Enhanced Wave (80mm glider cord only) are all supplied at an additional cost as per the price list.

- 2255 Adjustable brake
- 6364 Extension (for use with 6365)
- 6365 Hanger (for use with 6364)
- 6366 Carrier for draw rod

Roller gliders must be ordered separately
6098W Wave roller glider 80mm

Optional enhanced components to improve the presentation of the curtain:

- 3582 Hook
- 6349 Curtain tape
- 6363 Iron-on top hemming tape
- 10075 Lead weight for bottom hem 50gr/m
- 10076 Fabric weight for side of curtain

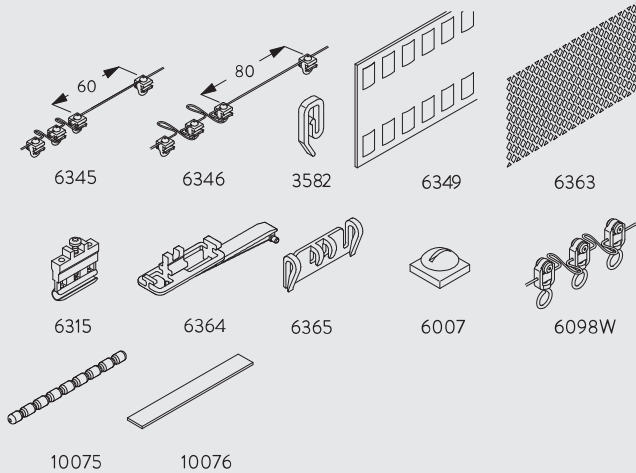

Fitting Information

WARNING

Young children can be strangled by loops in pullcords, chains, tapes and inner cords that operate the product. To avoid strangulation and entanglement, keep cords out of the reach of young children. Cords may become wrapped around a child's neck. Move beds, cots and furniture away from window covering cords. Do not tie cords together. Make sure cords do not twist to create a loop.

Bracket positioning

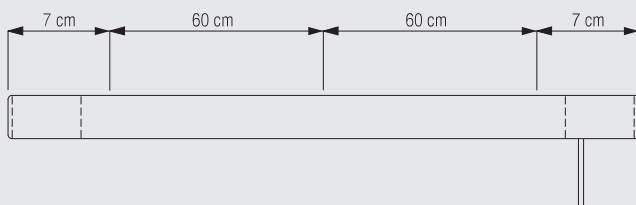

An additional bracket may be required near the 'cord-end' of the system if the system is carrying very heavy curtains.

6120M

Fitting of track to brackets

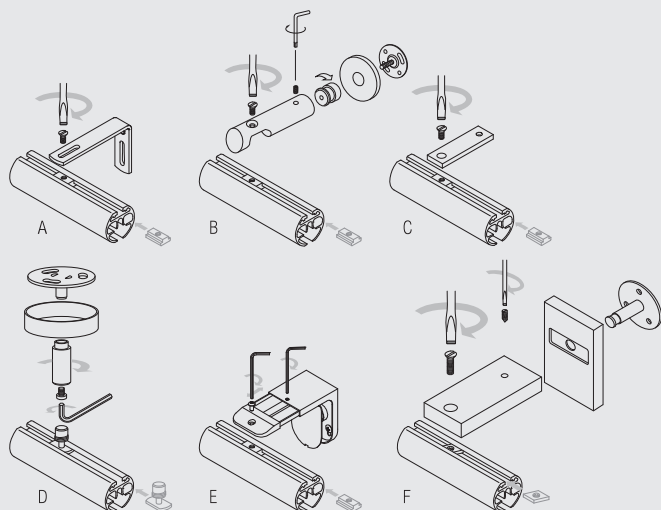

- A: Using bracket sets 11206-11208/11216-11218/11209
- B: Using pillar bracket 0674
- C: Using ceiling support 6138P
- D: Using top fix bracket 0335
- E: Using maxi adjustable bracket 0334
- F: Using blok bracket 0989

Fitting bent tracks

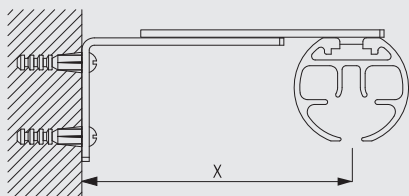

Note: all bent Metropole systems are supplied with adjustable brackets 11209 as standard.

Fitting Options

Wall fix with adjustable Smart Fix bracket 11209

6120M

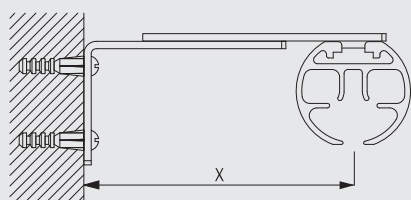

X (mm)	
11209	80-100

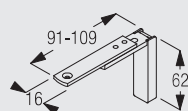

11209
Smart Fix with
extension arm set

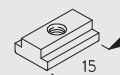

6141
Track insert (uses
screw 0798)

Note: all bent Metropole systems are supplied with adjustable brackets 11209 as standard.

Brackets feature slot for screw M4x8

Wall fix with Pillar bracket 0674

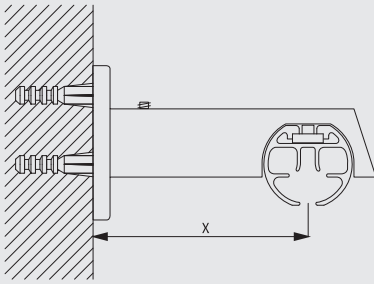

	x (mm)
0674	90

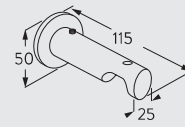

0674
Pillar bracket (30 mm poles only)

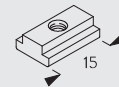

6141
Track insert (uses screw 0798)

Ceiling fix with support 6138P

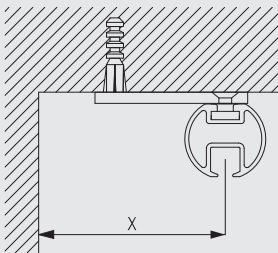

	X (mm)
6138P	80

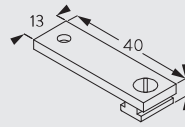

6138p
Ceiling support set (3mm)

The final distances may be outside of the recommendations above depending on curtain make-up and any obstructions.

Ceiling fix with support 6138P2

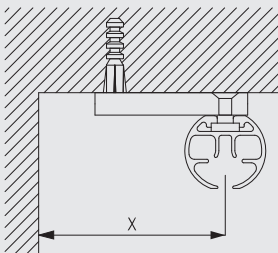

	X (mm)
6138P2	80

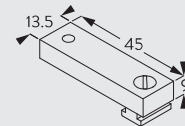

6138P2
Ceiling support set (9mm)

The minimum distance of 'x' will be 45mm (equal to the length of the bracket) but the actual distance will depend on the curtain make-up and any obstructions.

Ceiling fix with support 6138P6

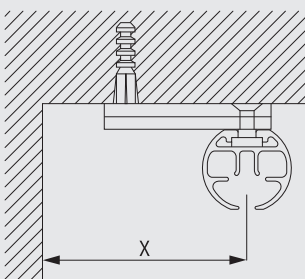

	X (mm)
6138P6	9

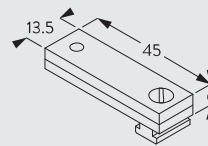

6138p6
Ceiling support set (6mm)

The final distances may be outside of the recommendations above depending on curtain make-up and any obstructions.

6120M

Ceiling fix with top fix bracket 0335

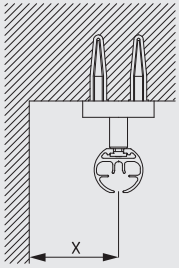

	X (mm)
0335	50

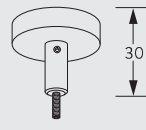

0335
Top fix bracket

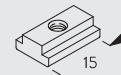

6141
Track insert (uses
screw 0798)

Wall fix with maxi adjustable bracket 0334

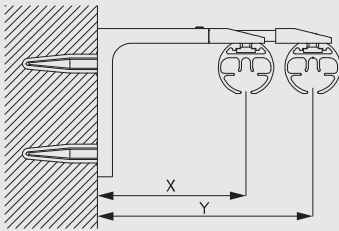

	X (mm)	Y (mm)
0334	80	100

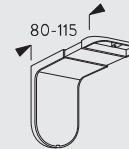

0334
Maxi adjustable
bracket

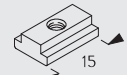

6141
Track insert (uses
screw 0798)

Wall fitting with Smart Fix with slot 11206-11208

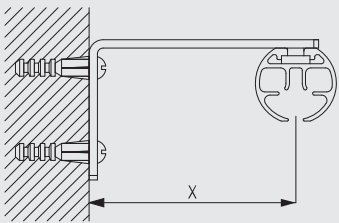

	X(mm)
11206	33-51
11207	53-71
11208	73-91

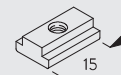

6141
Track insert (uses
screw 0798)

Brackets feature slot for screw M4x8

6120M

Wall fitting with Square Smart Fix with slot 11216-11218

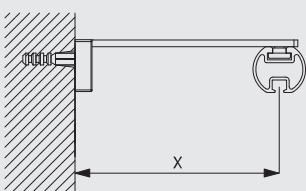

	X (mm)
11216	33-51
11217	53-71
11218	73-91

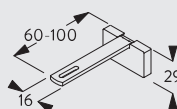

11216-18
Square Smart Fix
with slot (60-100
mm)

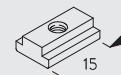

6141
Track insert (uses
screw 0798)

Brackets feature slot for screw M4x8

Wall fitting with Blok bracket

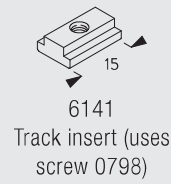
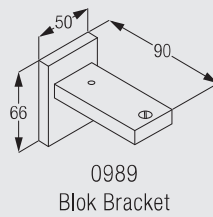
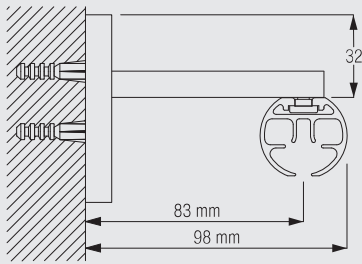

Standard Accessories

0340	Cording set (30mm)		0346	Flush endcap (30mm)	
3091	Cord		6063	Metal overlap arm	
6065	Twist eye endstop		6086	Spring stop	
6106	Profile		6141	Track insert (uses screw 0798)	
6143	Glider 6144 in strip form		6784	Machine screw (for 6141 insert)	
10400	Safety Cord Retainer		11206	Smart Fix, 60 mm with slot set	
11209	Smart Fix with extension arm set				

6120M





Optional Accessories

Single Parts







0311	Fused barrel (30mm)		0311	Fused barrel (30mm)	
0324	Fused ball (30mm)		0331	Glass ball (30mm)	
0334	Maxi adjustable bracket		0335	Top fix bracket	
0556	Ball end finial (30 mm)		0629	Groove Cylinder (30mm)	
0674	Pillar bracket (30 mm poles only)		0707	End cover (30mm)	

0719	Spear finial		0770	Finial connecting bracket	
0886	Crystal cube (30mm pole)		0901	Strata (30mm)	
0986	Groove Ball (30mm)		0989	Blok Bracket	
6063	Metal overlap arm		6283	Roller glider	
11207	Smart Fix, 80 mm with slot set		11208	Smart Fix, 100 mm with slot set	
11216	Square Smart Fix, 60 mm with slot set		11217	Square Smart Fix, 80 mm with slot set	
11218	Square Smart Fix, 100 mm with slot set		6138P2	Ceiling support set (9mm)	
6138p6	Ceiling support set (6mm)		6138p	Ceiling support set (3mm)	

Sets

6165	Intermediate pulley, containing		0708	Intermediate pulley cover	1	
			3810	Pulley	2	
			6103	Profile	1	
			6164	Clamping piece	1	
			6169	Holder	1	

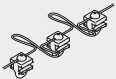
Wave Accessories

2216	Cord		3582	Hook		
6007	Endstop		6315	Pilot runner		
6345	Wave glider cord (60mm)		6346	Wave glider cord (80mm)		
6349	Wave curtain heading tape		6363	Top hemming tape		

6364 Extension

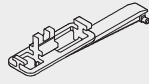

6365 Hanger



6383 Limit stop



10075 Lead weight 50 gr/m

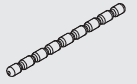

10076 Fabric weight



6098W Wave roller glider cord (80mm)



Useful measurements

6063 Metal overlap arm

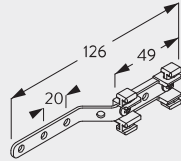

6120M

6120M



thehomeofinteriors.co.uk

The Design Hub
41 Brookley Road
Brockenhurst, Hampshire
SO42 7RB
sales@thehomeofinteriors.co.uk
Tel: 01590 615775

www.silentgliss.co.uk

www.silentglissglobal.com

Silent Gliss Ltd
Pyramid Business Park
Poorhole Lane
Broadstairs
Kent
CT10 2PT
Great Britain

Tel: +44 (0) 1843 863571
Fax: +44 (0) 1843 864503
info@silentgliss.co.uk

Silent Gliss Global Ltd
Pyramid Business Park
Poorhole Lane
Broadstairs
Kent
CT10 2PT
Great Britain

Tel: +44 (0) 1843 874250
Fax: +44 (0) 1843 874457
info@silentglissglobal.com