

Decorative Curtain Poles



www.thehomeofinteriors.co.uk

Email: sales@thehomeofinteriors.co.uk

Tel: 01590 615775



Hand Operated Curtain Pole System

Silent Gliss® 1003M Metropole 23mm

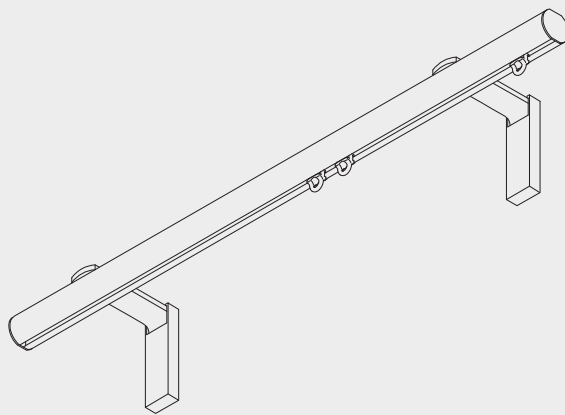

Product Information

- Hand operated decorative curtain poles for domestic and contract applications
- Ideal for bay windows
- For light to medium weight curtains
- Made to measure
- Profile length 6m (chrome effect 3.95m)
- 7 different finishes - charcoal, silver, chrome effect, gunmetal, ecru, matt white and white
- Range of decorative finial designs in different styles and colours
- Wall fix or ceiling fix
- Unlike other poles, 1003 can be bent to a small radius for bay windows etc.

1003M

Profile, Bending and Specification Information

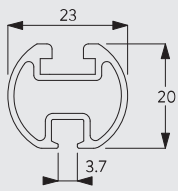

1003



Standard radius 150mm

Specification Guide - download from www.silentgliss.co.uk (password required).

Silent Gliss 1003 curtain track, hand drawn, aluminium, assembled complete with gliders 3533 at 16/m, 2 endcovers 0339 and 2 endstops 3070. Face fix with brackets 11206-208/11216-218/11209/0334. Top fix with 6138P/ 0335. Available in charcoal, matt white, white, silver, gunmetal, ecru and chrome effect.

How To Measure

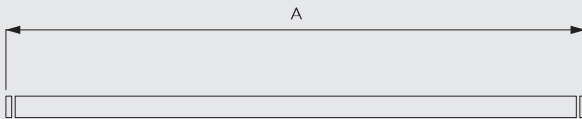

A: System Width - includes finials. See 'Design Options' for finial sizes.

Design Options

Endcaps

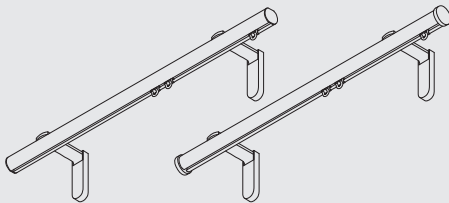

Without finials, poles are supplied as standard with flush fitting endcaps 0339 (left). Alternatively, stud endcaps 0706 (right) can be selected at no additional cost.

Finials

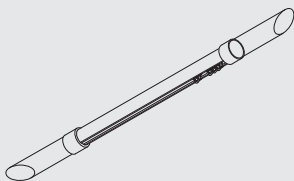

Finials are decorative elements that fit at the end of the pole.

1003M

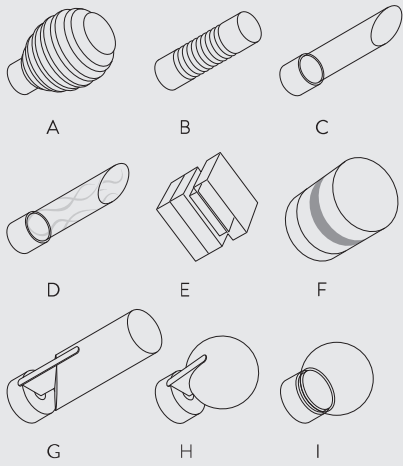

- A: 0985 Groove Ball 85mm
- B: 0628 Groove Cylinder 80mm
- C: 0993CL Shard (clear) 112mm
- D: 0993ET Shard (etched) 112mm
- E: 0884 Crystal Cube 33mm (green, black, brown)
- F: 0894 Crystal Cylinder 55mm (green, black, brown)
- G: 0308 Fused Barrel 90mm (walnut/oak/colour matched)
- H: 0321 Fused Ball 48mm (walnut/oak/colour matched)
- I: 0329 Glass Ball (clear/frosted) 45mm

Consult the Metropole brochure for full range details.

Fitting Information

Bracket positioning



Fitting of track to brackets

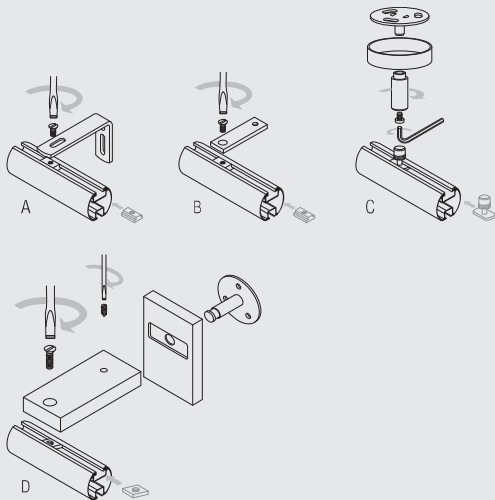

- A: Using bracket sets 11206-11208/11216-218
- B: Using top fix plate 6138P
- C: Using top fix bracket 0335
- D: Using blok bracket 0989

1003M

Fitting of bent poles

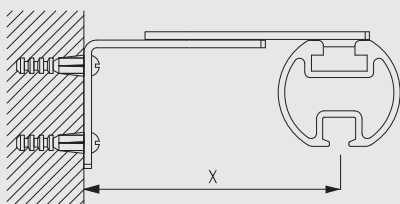

Note: all bent Metropole systems are supplied with adjustable bracket set 11209 as standard.

X = 80-100mm

Fitting Options

Ceiling fix with support 6138P

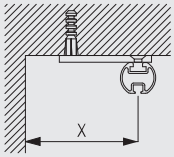

	X (mm)
6138P	80

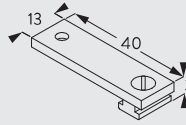

6138p
Ceiling support set
(3mm)

The final distances may be outside of the recommendation above depending on curtain make-up and any obstructions.

Wall fix with adjustable Smart Fix bracket with slot 11209

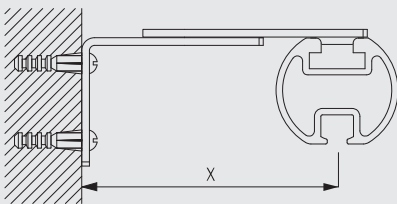

	X (mm)
11209	80-100

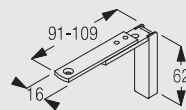

11209
Smart Fix with
extension arm set

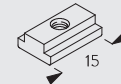

6141
Track insert (uses
screw 0798)

All bent Metropole poles are supplied with these adjustable bracket set 11209 as standard.

Brackets feature slot for screw M4x8

Ceiling fix with top fix bracket 0335

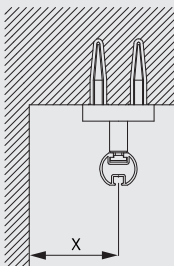

	X (mm)
0335	50

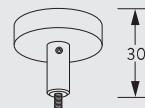

0335
Top fix bracket

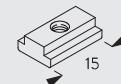

6141
Track insert (uses
screw 0798)

Wall fitting with Smart Fix with slot 11206-11208

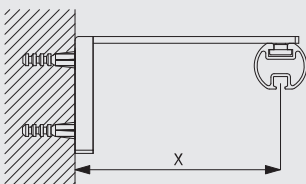

	X (mm)
11206	33-51
11207	53-71
11208	73-91

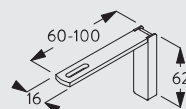

11206-08
Smart Fix with slot
(60-100 mm)

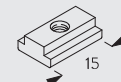

6141
Track insert (uses
screw 0798)

Brackets feature slot for screw M4x8

1003M

Wall fitting with Square Smart Fix with slot 11216-11218

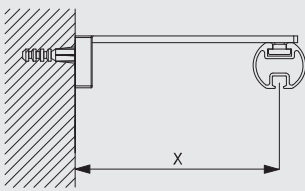

	X (mm)
11216	33-51
11217	53-71
11218	73-91

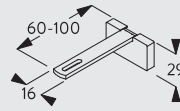

11216-18
Square Smart Fix
with slot (60-100
mm)

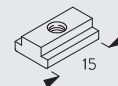

6141
Track insert (uses
screw 0798)

Brackets feature slot for screw M4x8

Wall fix with Blok bracket 0989

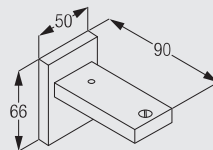
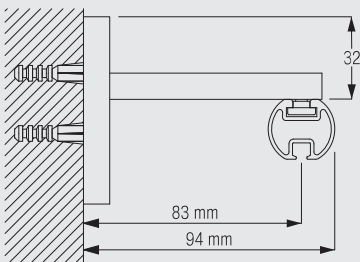

0989
Blok Bracket

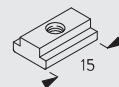

6141
Track insert (uses
screw 0798)

Standard Accessories

0339 Flush endcap (23mm)



1003 Profile



3070 Twist eye endstop



3534 Glider 3533 in strip form



6141 Track insert (uses screw 0798)



6784 Machine screw (for 6141 insert)

1003M

11206 Smart Fix, 60 mm with slot set



11209 Smart Fix with extension arm set

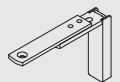

Optional Accessories

0308 Fused barrel (23mm)

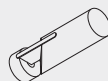

0321 Fused ball (23mm)



0329 Glass ball (23mm)



0335 Top fix bracket



0628 Groove Cylinder (23mm)

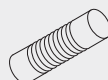

0706 Stud Endcap (23mm)



0884 Crystal cube (23mm pole)



0894 Crystal cylinder (23mm)



0985 Groove Ball (23mm)



0989 Blok Bracket

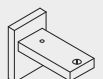

3582	Hook		10430	Draw rod with hook, 50cm	
10431	Draw rod with hook, 75cm		10432	Draw rod with hook, 100cm	
10433	Draw rod with hook, 125cm		10434	Draw rod with hook, 150cm	
11207	Smart Fix, 80 mm with slot set		11208	Smart Fix, 100 mm with slot set	
11209	Smart Fix with extension arm set		11216	Square Smart Fix, 60 mm with slot set	
11217	Square Smart Fix, 80 mm with slot set		11218	Square Smart Fix, 100 mm with slot set	
6138p	Ceiling support set (3mm)		0993CL	Shard Clear (23mm)	
0993ET	Shard Etched (23mm)				

1003M

1003M

1003M



thehomeofinteriors.co.uk

The Design Hub
41 Brookley Road
Brockenhurst, Hampshire
SO42 7RB
sales@thehomeofinteriors.co.uk
Tel: 01590 615775

www.silentgliss.co.uk

www.silentglissglobal.com

Silent Gliss Ltd
Pyramid Business Park
Poorhole Lane
Broadstairs
Kent
CT10 2PT
Great Britain

Tel: +44 (0) 1843 863571
Fax: +44 (0) 1843 864503
info@silentgliss.co.uk

Silent Gliss Global Ltd
Pyramid Business Park
Poorhole Lane
Broadstairs
Kent
CT10 2PT
Great Britain

Tel: +44 (0) 1843 874250
Fax: +44 (0) 1843 874457
info@silentglissglobal.com