

# Decorative Curtain Poles



---

[www.thehomeofinteriors.co.uk](http://www.thehomeofinteriors.co.uk)

Email: [sales@thehomeofinteriors.co.uk](mailto:sales@thehomeofinteriors.co.uk)

Tel: 01590 615775



## Hand Operated Curtain Pole System

# Silent Gliss® 6100M Metroflat 36mm

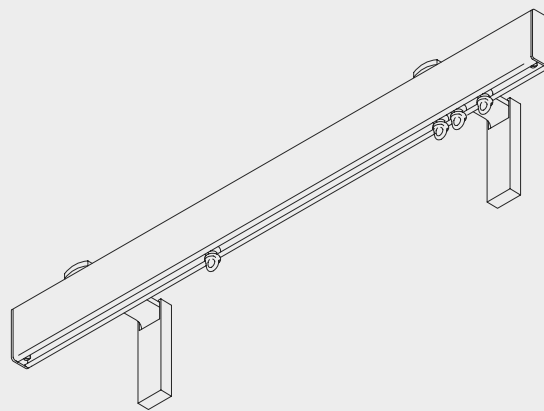

### Product Information

- Hand operated system for domestic and contract applications
- Attractive contemporary appearance for modern interiors
- Can be bent to a small radius for bay windows
- Available in 10 finishes - white, matt white, chrome effect, silver, black, slate grey, bronze, anodic grey, gunmetal and charcoal.
- Accessorised with endcaps or a range of finials
- Easy fitting to wall or ceiling
- For light to medium weight curtains
- Profile length 6m (chrome effect 3.95m)
- Suitable for Wave Standard curtain heading system

6100M

## Profile, Bending and Specification Information

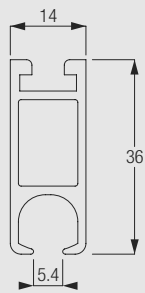

6101

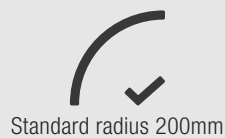

### Specification Information - download from [www.silentgliss.co.uk](http://www.silentgliss.co.uk)

Silent Gliss 6100M curtain track, hand drawn, aluminium, assembled complete with gliders 6143 at 10/m and 2 endcovers 0351. Face Face fix with brackets 11206-208/11216-218/11209/0334/0989. Top fix with bracket 6138P/ 0335 at 700mm centres. Finished in white, matt white, black, silver, gunmetal, antique bronze, slate grey, ecru, anodic grey or chrome effect.

## How To Measure

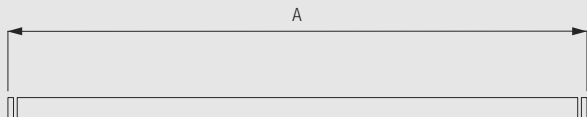

A: System Width - includes finials. See 'Design Options' for finial sizes.

## Stack Size Calculation Wave

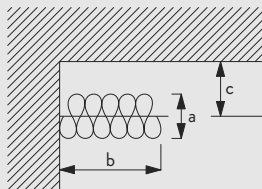

6100M

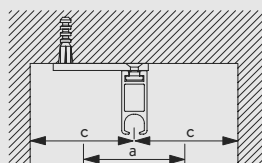

a = Stack depth  
b = Stack size  
c = Min. distance

Glider-cord spacing	Curtain hook spacing	Approx. curtain fullness	Stack depth (a)	Stack width (b)	Min distance (c)
6	10	2.1	10	23 per metre of track + endpiece	8
6	12	2.3	12	23 per metre of track + endpiece	9
8	14	2.1	14	18 per metre of track + endpiece	10
8	16	2.3	16	18 per metre of track + endpiece	11

Wave standard with roller gliders

Glider-cord spacing	Curtain hook spacing	Approx. curtain fullness	Stack depth (a)	Stack width (b)	Min distance (c)
8	14	2.1	14	21 per metre of track + endpiece	10
8	16	2.3	16	21 per metre of track + endpiece	11

(dimensions in cm)

Note: Minimum distance (c) includes a standard 3cm clearance (front and back).

## Design Options

### Endcaps

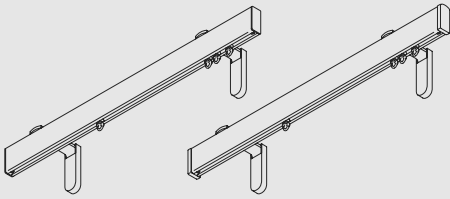

Without finials, poles are supplied as standard with flush fitting endcaps 0351 (left). Alternatively, stud endcaps 0710 (right) can be selected at no additional cost.

### Finials

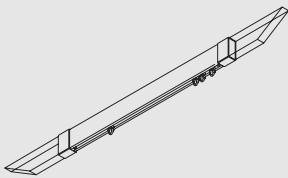

Finials are decorative elements that fix to the end of the pole.

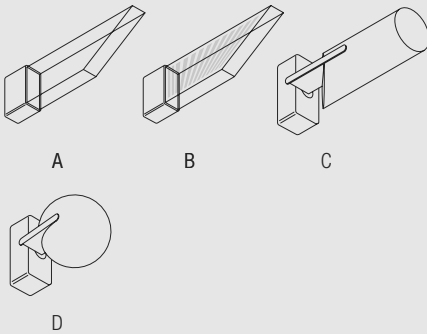

- A: 0991CL Shard (clear) 116mm
- B: 0991ET Shard (etched) 116mm
- C: Fused Barrel (walnut/oak/colour matched) 102mm
- D: Fused Ball (walnut/oak/colour matched) 63mm

Please consult the Metropole Brochure for full range details.

### Wave Standard curtain heading system

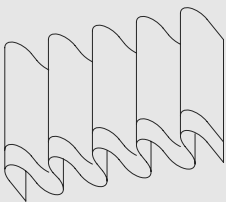

The Wave curtain heading system is an exciting contemporary curtain heading system which allows curtains to hang in a continuous wave which is smooth, simple and elegant.

When using the Wave curtain heading system please note the maximum recommended curtain weight is 2.5kg/m or 10kg/m with wave roller glider 6098W.

6100M

The Wave standard components are:

- 6345 Glider Cord 60mm
- 6346 Glider Cord 80mm
- 6007 End stop

The items listed below for Enhanced Wave (80mm glider cord only) are all supplied at an additional cost as per the price list.

- 2255 Adjustable brake
- 6364 Extension (for use with 6365)
- 6365 Hanger (for use with 6364)
- 6366 Carrier for draw rod

Roller gliders must be ordered separately  
6098W Wave roller glider 80mm

Optional enhanced components to improve the presentation of the curtain:

- 3582 Hook
- 6349 Curtain tape
- 6363 Iron-on top hemming tape
- 10075 Lead weight for bottom hem 50gr/m
- 10076 Fabric weight for side of curtain

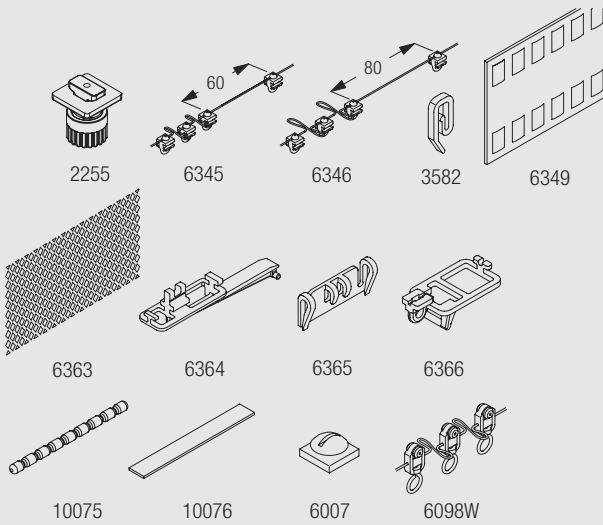

## Fitting Information

### Bracket positioning

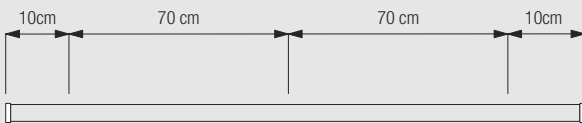

### Fitting of track to brackets

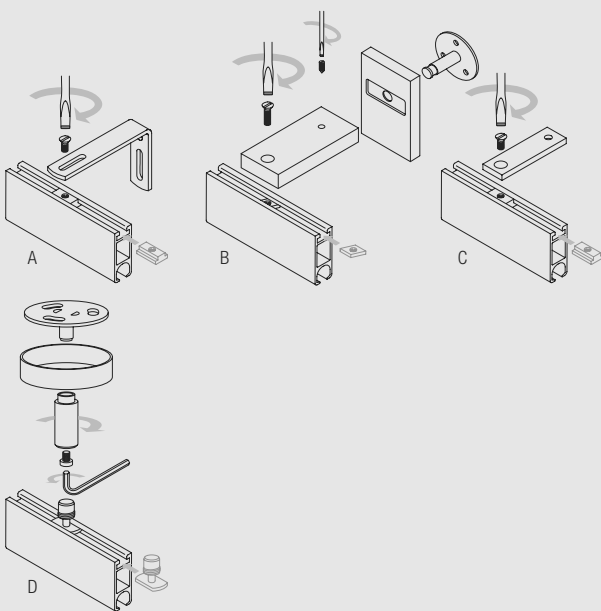

- A: Using bracket set 11206-11208/11216-218/11209
- B: Using Blok brackets 0989
- C: Using top fix plate 6138P
- D: Using top fix bracket 0335

## Fitting bent tracks.

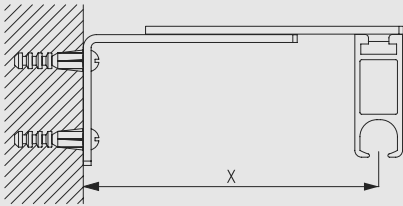

Note: all bent Metropole systems are supplied with adjustable bracket set 11209 as standard.

X = 80-100mm

## Fitting Options

### Wall fix with Blok brackets 0989

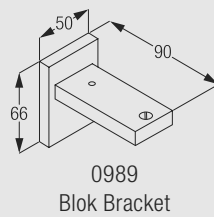
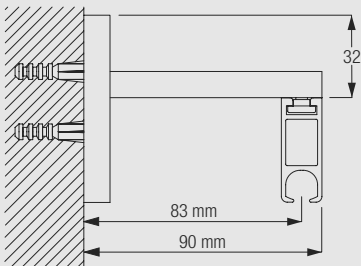

The final distances may be outside of the recommendations above depending on curtain heading, make-up and any obstructions.

### Ceiling fix with support 6138P

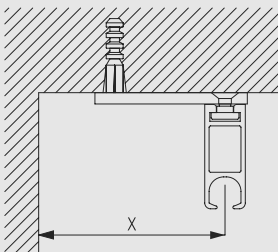

X (mm)  
80

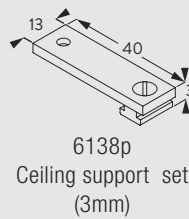

The final distances may be outside of the recommendations above depending on curtain heading, make-up and any obstructions.

### Wall fix with adjustable Smart Fix bracket 11209

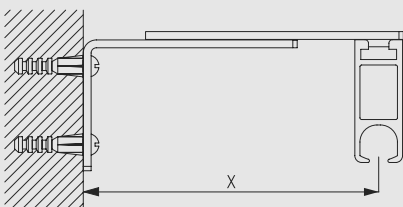

X (mm)  
11209 80-100

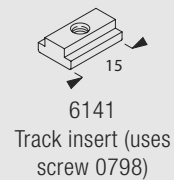
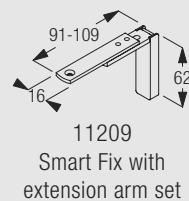

Brackets feature slot for screw M4x8

The final distances may be outside of the recommendations above depending on curtain heading, make-up and any obstructions.

All bent Metroflat 36mm systems are supplied with adjustable bracket set 11209 as standard.

6100M

## Ceiling Fix with Top Fix Bracket 0335

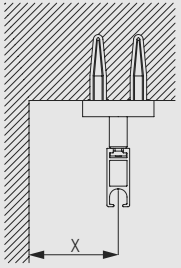

	X
0334	80

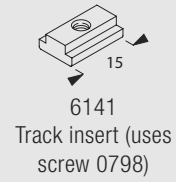

## Wall fitting with Smart Fix with slot 11206-11208

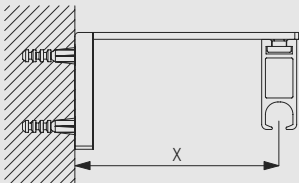

	X (mm)
11206	33-51
11207	53-71
11208	73-91

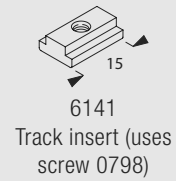
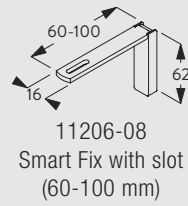

Brackets feature slot for screw M4x8

## Wall fitting with Square Smart Fix with slot 11216-11218

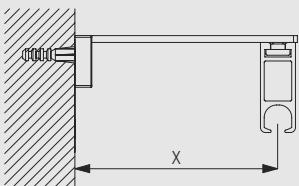

	X (mm)
11216	33-51
11217	53-71
11218	73-91

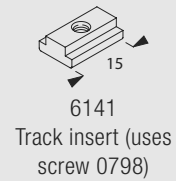
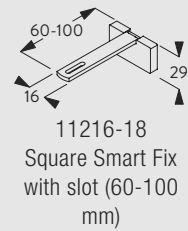

Brackets feature slot for screw M4x8

6100M

## Standard Accessories

### Parts

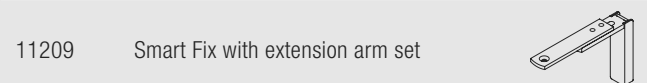
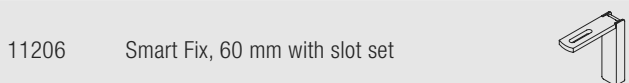
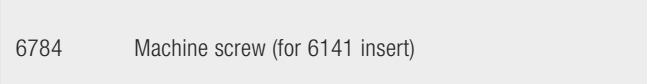
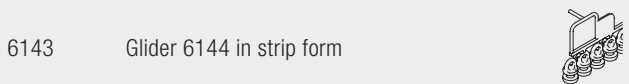
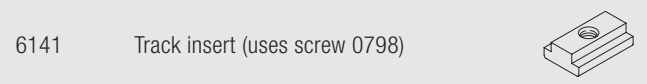
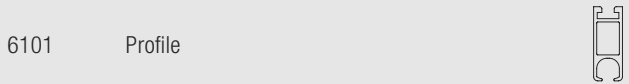
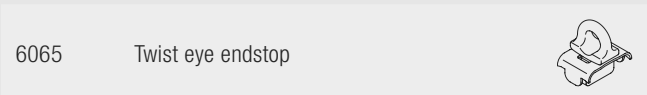
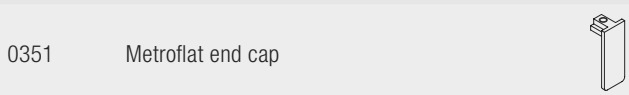



## Optional Accessories

### Parts

0304	Fused barrel (36mm)		0318	Fused ball (36mm)	
0335	Top fix bracket		0710	Stud Endcap	
0989	Blok Bracket		6283	Roller glider	
6398	Clip		11207	Smart Fix, 80 mm with slot set	
11208	Smart Fix, 100 mm with slot set		11209	Smart Fix with extension arm set	
11216	Square Smart Fix, 60 mm with slot set		11217	Square Smart Fix, 80 mm with slot set	
11218	Square Smart Fix, 100 mm with slot set		6138p	Ceiling support set (3mm)	
0991CL	Shard Clear Metroflat		0991ET	Shard Etched Metroflat	

## Wave Accessories

2255	Adjustable brake		3582	Hook	
6007	Endstop		6345	Wave glider cord (60mm)	
6346	Wave glider cord (80mm)		6349	Wave curtain heading tape	
6363	Top hemming tape		6364	Extension	
6365	Hanger		6366	Wave carrier for draw rod	
10075	Lead weight 50 gr/m		10076	Fabric weight	
6098W	Wave roller glider cord (80mm)				

6100M

6100M

6100M



[thehomeofinteriors.co.uk](http://thehomeofinteriors.co.uk)

The Design Hub  
41 Brookley Road  
Brockenhurst, Hampshire  
SO42 7RB  
[sales@thehomeofinteriors.co.uk](mailto:sales@thehomeofinteriors.co.uk)  
Tel: 01590 615775

[www.silentgliss.co.uk](http://www.silentgliss.co.uk)

[www.silentglissglobal.com](http://www.silentglissglobal.com)

Silent Gliss Ltd  
Pyramid Business Park  
Poorhole Lane  
Broadstairs  
Kent  
CT10 2PT  
Great Britain

Tel: +44 (0) 1843 863571  
Fax: +44 (0) 1843 864503  
[info@silentgliss.co.uk](mailto:info@silentgliss.co.uk)

Silent Gliss Global Ltd  
Pyramid Business Park  
Poorhole Lane  
Broadstairs  
Kent  
CT10 2PT  
Great Britain

Tel: +44 (0) 1843 874250  
Fax: +44 (0) 1843 874457  
[info@silentglissglobal.com](mailto:info@silentglissglobal.com)