

Hand Operated Curtain Track Systems



www.thehomeofinteriors.co.uk

Email: sales@thehomeofinteriors.co.uk

Tel: 01590 615775



Hand Operated Curtain Track System

Silent Gliss® 6870

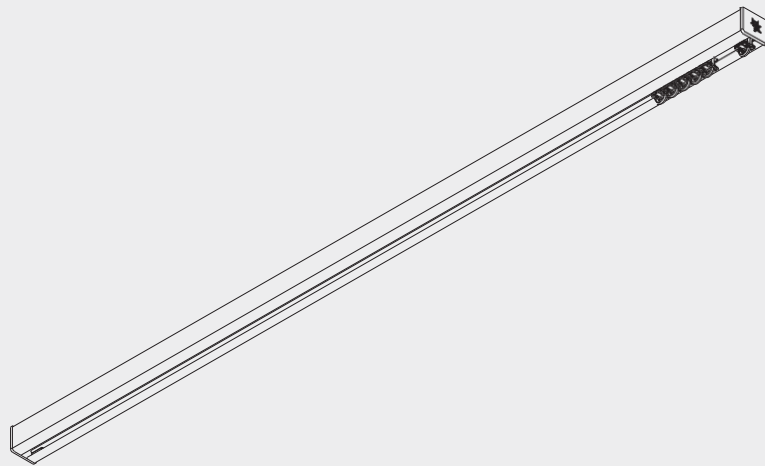

Product Information

- Operation: hand drawn
- Range: M
- Fitting: ceiling, wall, recess
- Colours: white, matt white, silver anodised, anodic grey, charcoal and antique bronze
- Square shaped design
- 2C glider technology
- Wave compatible
- Bendable (including recess profile)



6870

Profile and Bending Information

Profile

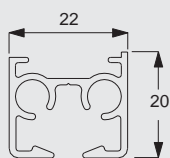

11190



Radius: >26 cm

Recess profile

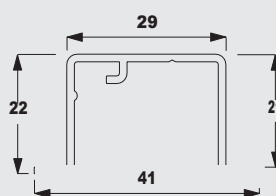

11230



Radius: >50 cm

Specification text:

Silent Gliss SG 6870 Hand Operated Curtain Track System. Comprises aluminium profile SG 11190 supplied made to measure, available in silver anodised or powder coated in white/matt white/ anodic grey/ antique bronze/charcoal. Supplied as standard with 2C gliders SG 11300 at 14/m, 2 end covers SG 11233 and 2 end stops SG 6065. Top fixed with fixing clamp SG 3825 at 500mm centres. Optional top fix bracket SG 3832 / Wall fix with SG Smart Fix brackets SG 11201-11205 and SG 3826 or SG 3832 / Square Smart Fix brackets SG 11210-11215 and SG 3826 or SG 3832 / SG Universal Smart Fix brackets SG 11154-11156

How To Measure

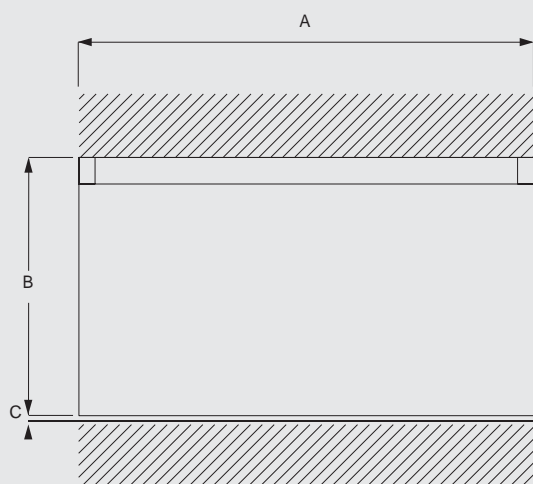

- A: System width
- B: System height
- C: Distance between floor and fabric

6870

System Options

Wave Curtain Heading System

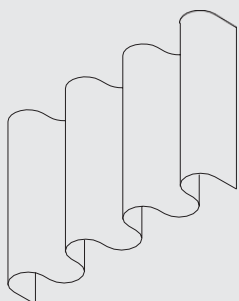

The Wave standard components are:

- 11303 Wave 2C Glider Cord 60mm
- 11302 Wave 2C Glider Cord 80mm
- 6007 Endstop
- 6315 Pilot runner

The items listed below for Enhanced Wave (80mm glider cord only) are all supplied at an additional cost as per the price list.

- 2255 Adjustable brake
- 6364 Extension (used with 6365)
- 6365 Hanger (used with 6364)
- 6366 Carrier for draw rod

Roller Gliders must be ordered separately
6099 Wave roller glider 80mm

Optional components to improve the presentation of the curtain:

- 3582 Hook
- 6349 Curtain tape
- 6363 Iron-on top hemming tape
- 10075 Lead weight for hem of curtain 50gr/m
- 10076 Fabric weight for side edge of curtain

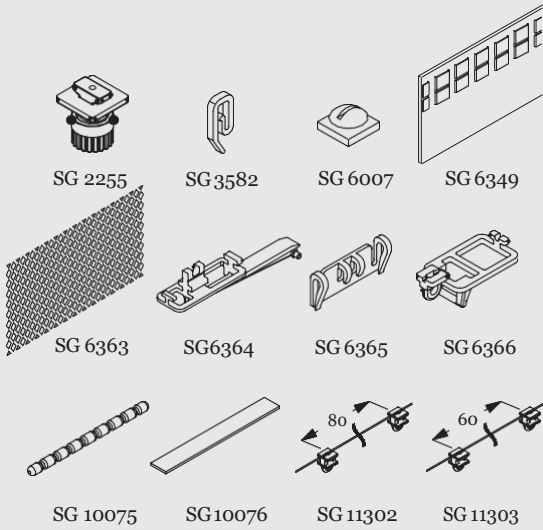

Fitting Information

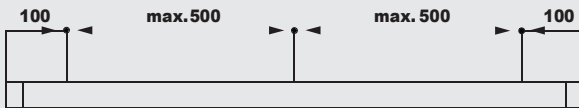

Fitting Options

Ceiling fitting with clamp SG 3825

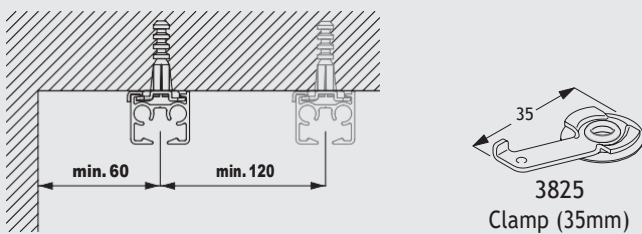

Ceiling fitting with bracket SG 3826

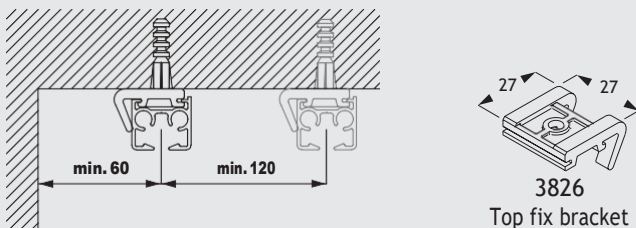

Ceiling fitting with bracket SG 3832

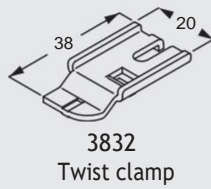
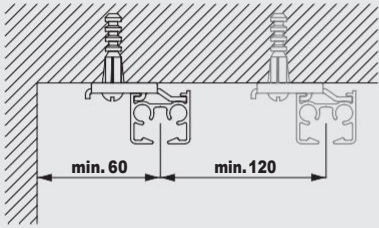

Wall fitting with Smart Fix SG 11200-11205 and bracket SG 3826

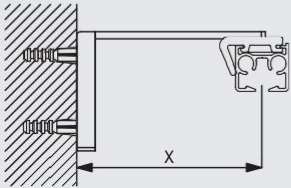

	X (mm)
11200	52
11201	72
11202	92
11203	112
11204	142

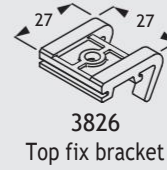
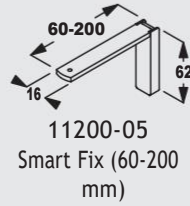

Brackets threaded for screw M4 x 8

Wall fitting with Square Smart Fix SG 11210-11215 and bracket SG 3826

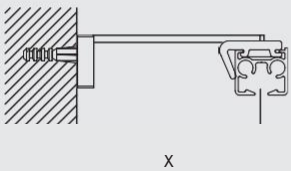

	X (mm)
11210	52
11211	72
11212	92
11213	112
11214	142
11215	192

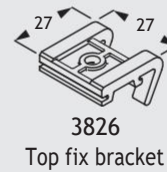
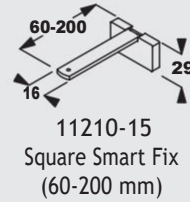

6870

Brackets threaded for screw M4x8

Wall fitting with Universal Smart Fix SG 11154-11156 and bracket SG 3826

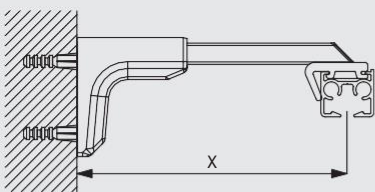

	X (mm)
11154	102-130
11155	132-160
11156	182-210

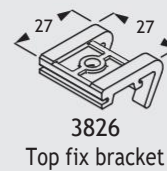
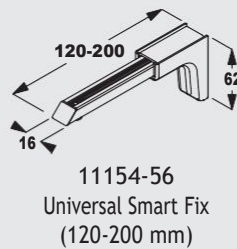

Brackets threaded for screw M4 x 8

Wall fitting with Smart Fix SG 11200-11205 and bracket SG 3832

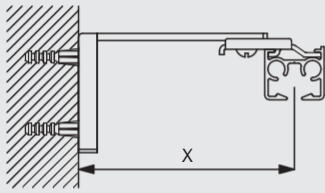

	X (mm)
11200	70
11201	90
11202	110
11203	130
11204	160
11205	210

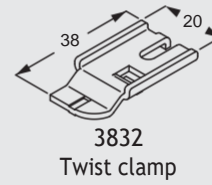
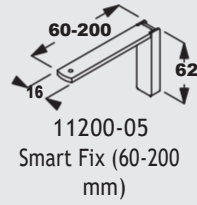

Brackets threaded for screw M4 x 8

Wall fitting with Square Smart Fix SG 11210-11215 and bracket SG 3832

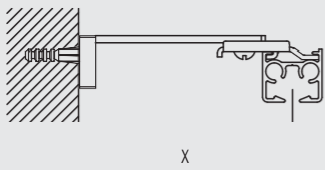

	X (mm)
11210	70
11211	90
11212	110
11213	130
11214	160
11215	210

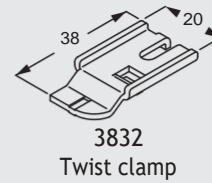
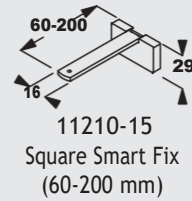

Brackets threaded for screw M4 x 8

Wall fitting with Universal Smart Fix SG 11154-11156 and bracket SG 3832

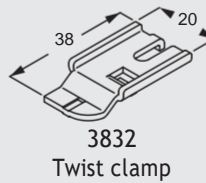
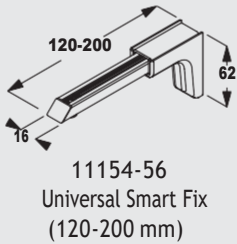
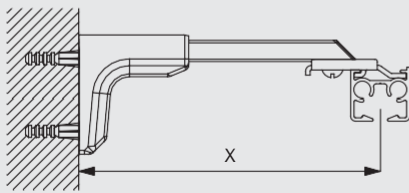

Brackets threaded for screw M4 x 8

Wall fitting with bracket SG 3836

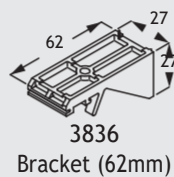
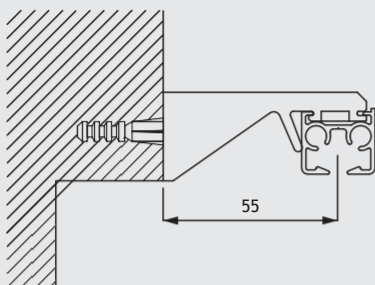

Recess fitting with recess profile SG 11230

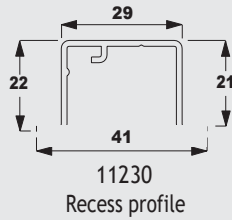
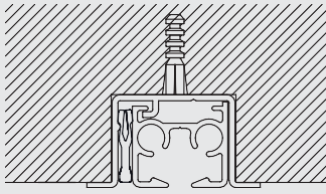

11238
Recess Mask

Standard Accessories

3825 Clamp (35mm)



6065 Twist eye endstop



11190 Profile



11233 End cover



11301 2C glider 11300 on strip (x20)

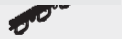

Optional Accessories

3582 Hook



3599 Hook



3802 Connecting bridge



3826 Top fix bracket



3832 Twist clamp



3836 Bracket (62mm)

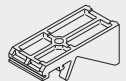

6007 Endstop



6053 Spring stop



6064 Screw twist endstop



6094 Roller glider with hook



6098 Roller glider with eye



6283 Roller glider



10157 Clamp



10407 Pan head screw M4x10



10430 Draw rod with hook, 50cm



10431 Draw rod with hook, 75cm



10432 Draw rod with hook, 100cm



10433 Draw rod with hook, 125cm









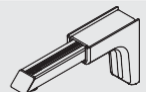

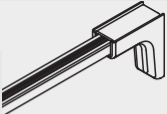

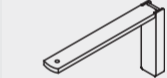
10434 Draw rod with hook, 150cm

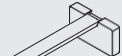

11154 Universal Smart Fix, 120 mm set

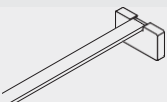

11155	Universal Smart Fix, 150 mm set		11156	Universal Smart Fix, 200 mm set	
11200	Smart Fix, 60 mm set		11201	Smart Fix, 80 mm set	
11202	Smart Fix, 100 mm set		11203	Smart Fix, 120 mm set	
11204	Smart Fix, 150 mm set		11205	Smart Fix, 200 mm set	
11210	Square Smart Fix, 60 mm set		11211	Square Smart Fix, 80 mm set	
11212	Square Smart Fix, 100 mm set		11213	Square Smart Fix, 120 mm set	
11214	Square Smart Fix, 150 mm set		11215	Square Smart Fix, 200 mm set	
11230	Recess profile		11238	Recess Mask	

Wave Accessories

2255	Adjustable brake		6099	Wave roller glider cord (80mm)	
6349	Curtain tape		6363	Top hemming tape	
6364	Extension		6365	Hanger	
6366	Wave carrier for draw rod		10075	Lead weight 50 gr/m	
10076	Fabric weight		11302	Wave 2C glider cord 80 mm	
11303	Wave 2C glider cord 60 mm				

6870



6870



6870

www.thehomeofinteriors.co.uk
Email: sales@thehomeofinteriors.co.uk
Tel: 01590 615775

www.silentgliss.co.uk

www.silentglissglobal.com

Silent Gliss Ltd
Pyramid Business Park
Poorhole Lane
Broadstairs
Kent
CT102PT
Great Britain

Tel: +44 (0) 1843 863571
Fax: +44 (0) 1843 864503
info@silentgliss.co.uk

Silent Gliss Global Ltd
Pyramid Business Park
Poorhole Lane
Broadstairs
Kent
CT102PT
Great Britain

Tel: +44 (0) 1843 874250
Fax: +44 (0) 1843 874457
info@silentglissglobal.com