

CONTACT

www.bradleycollection.com



UK & REST OF THE WORLD

☎ +44 (0)1449 722 724

✉ info@bradleycollection.com

USA & CANADA

☎ +1 (310) 815 8255

✉ info.us@bradleycollection.com

the**bradley**collection

Specialised fixings for mounting brackets will be required in certain situations and are not provided as standard.
Steel items are not recommended for damp conditions such as shower rooms.
Crystal finials and acrylic poles should not be positioned in direct sunlight, and are not suitable for use in conservatories.
Fluid Metal items are supplied unlacquered and will tarnish over time.

The Bradley Collection reserves the right to modify design and materials without prior notice as part of a process of continual product improvement.

Products are protected by Design Rights, under provisions of Copyright, Designs & Patents Act 1988.
Bradley®, The Bradley Collection® and  Logo are registered Community trademarks of The Bradley Collection Ltd. in Europe and registered trademarks of the Bradley Collection, Inc. in the USA.

The Bradley Collection Ltd Lion Barn • Maitland Road • Needham Market • Suffolk • IP6 8NS • UK

Published: 1021 • Copyright © The Bradley Collection Ltd. 2022

THE **BRADLEY** COLLECTION

GLIDERPOLE[®]

INSTALLATION INSTRUCTIONS

INSTALLATION INSTRUCTIONS

THANK YOU FOR YOUR ORDER

Before fitting this product please ensure that you have thoroughly read these instructions.

We have taken every care to design and manufacture a quality system; incorrect installation could lead to poor performance.

If any queries arise when reviewing these instructions or during installation please feel free to contact us for assistance. We will be glad to talk you through the process.

Please retain these instructions for future reference.

SHARE YOUR INSTALL ON INSTAGRAM

 TAG: @bradleycollection



Introduction Page 2

FIXINGS Page 2

TOOLS Page 2

CARE & MAINTENANCE Page 2

Flat & Round Gliderpoles Page 3-4

Square Gliderpoles Page 5-6

Alternative Brackets Page 7-8

Adding/Removing Gliders & Rollers Page 9

Corded Systems Page 10

FIXINGS

As a courtesy we have supplied a set of fixings for the system.

These screws and wall plugs are designed to be used in wood and brick walls. We understand our systems may be used on a variety of materials; drywall, aluminium and steel stud, or lath and plaster.

To properly secure a system onto these or other types of surfaces; appropriate fixings must be independently obtained.

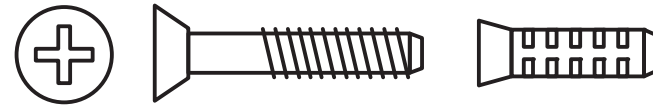

Assess your own wall construction and source the appropriate screw type.
PLEASE NOTE, that the enclosed fixings may not be suitable for all wall types.

TOOLS

For the installation of the system the following items may be required.

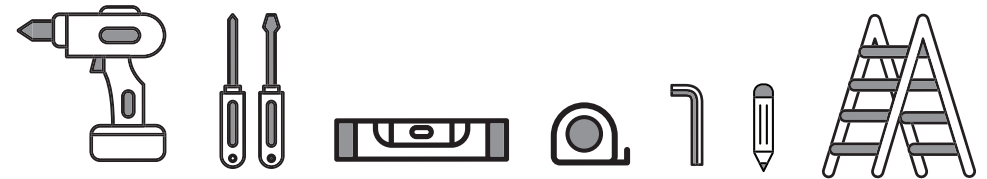

CARE & MAINTENANCE

This gliderpole can be cleaned using a soft cloth and furniture polish.



Please do not use any solvent or chlorine based cleaners as this will damage the finish.

POSITIONING & FIXING SINGLE & DOUBLE BRACKETS FOR ALTERNATIVE BRACKETS TYPES SEE PAGE 7-8

Brackets should be positioned approximately 100mm (4") from the ends of the pole.

- 1 Mark the position of the brackets. For longer poles one or more mid bracket are required, and should be equally spaced along the system.
PLEASE NOTE, Where systems are made in multiple sections. Joins must be supported by a mid bracket, which must be fitted directly over the join.
To align the brackets, the top of the mid brackets should be fitted in line with the top of the side brackets.

- 2 Drill holes & use a suitable wall fixing when attaching the plate to the wall.
- 3 Screw each bracket into position.
- 4 Fit the cover plate, the cover is held in place by magnets.

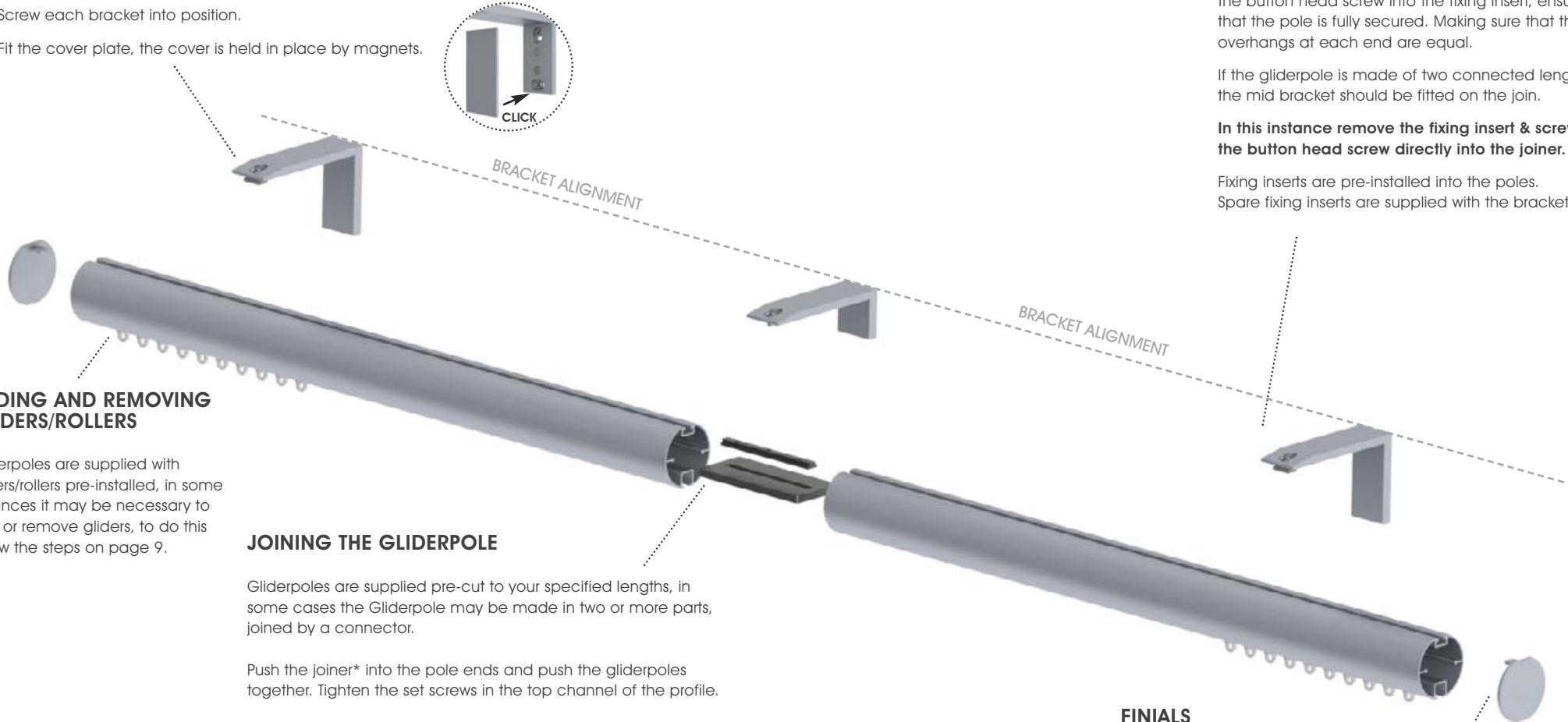

ADDING AND REMOVING GLIDERS/ROLLERS

Gliderpoles are supplied with gliders/rollers pre-installed, in some instances it may be necessary to add or remove gliders, to do this follow the steps on page 9.

JOINING THE GLIDERPOLE

Gliderpoles are supplied pre-cut to your specified lengths, in some cases the Gliderpole may be made in two or more parts, joined by a connector.

Push the joiner* into the pole ends and push the gliderpoles together. Tighten the set screws in the top channel of the profile.

- 1 **PLEASE NOTE, All joins must be supported by a bracket. If there is a gap between joins gliders/rollers may not run efficiently.**

* Internal joiner will vary between gliderpole type and diameter.

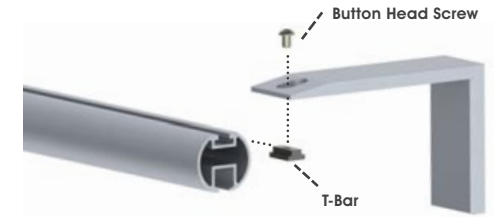

FITTING GLIDERPOLE TO THE BRACKETS

Offer the gliderpole up to the bracket, and tighten the button head screw into the fixing insert, ensuring that the pole is fully secured. Making sure that the overhangs at each end are equal.

If the gliderpole is made of two connected lengths, the mid bracket should be fitted on the join.

In this instance remove the fixing insert & screw the button head screw directly into the joiner.

Fixing inserts are pre-installed into the poles. Spare fixing inserts are supplied with the brackets.

FINIALS

Attach the finials by pushing them into position and tightening the set screws on the finial.

**POSITIONING & FIXING
SINGLE & DOUBLE BRACKETS** FOR ALTERNATIVE BRACKETS TYPES SEE PAGE 7-8

Brackets should be positioned approximately 100mm (4") from the ends of the pole.

- 1 Mark the position of the brackets. For longer poles one or more mid bracket are required, and should be equally spaced along the system.
PLEASE NOTE, Where systems are made in multiple sections. Joins must be supported by a mid bracket, which must be fitted directly over the join.
To align the brackets, the top of the mid brackets should be fitted in line with the top of the side brackets.

- 2 Drill holes & use a suitable wall fixing when attaching the plate to the wall.
- 3 Screw each bracket into position.
- 4 Fit the cover plate, the cover is held in place by magnets.

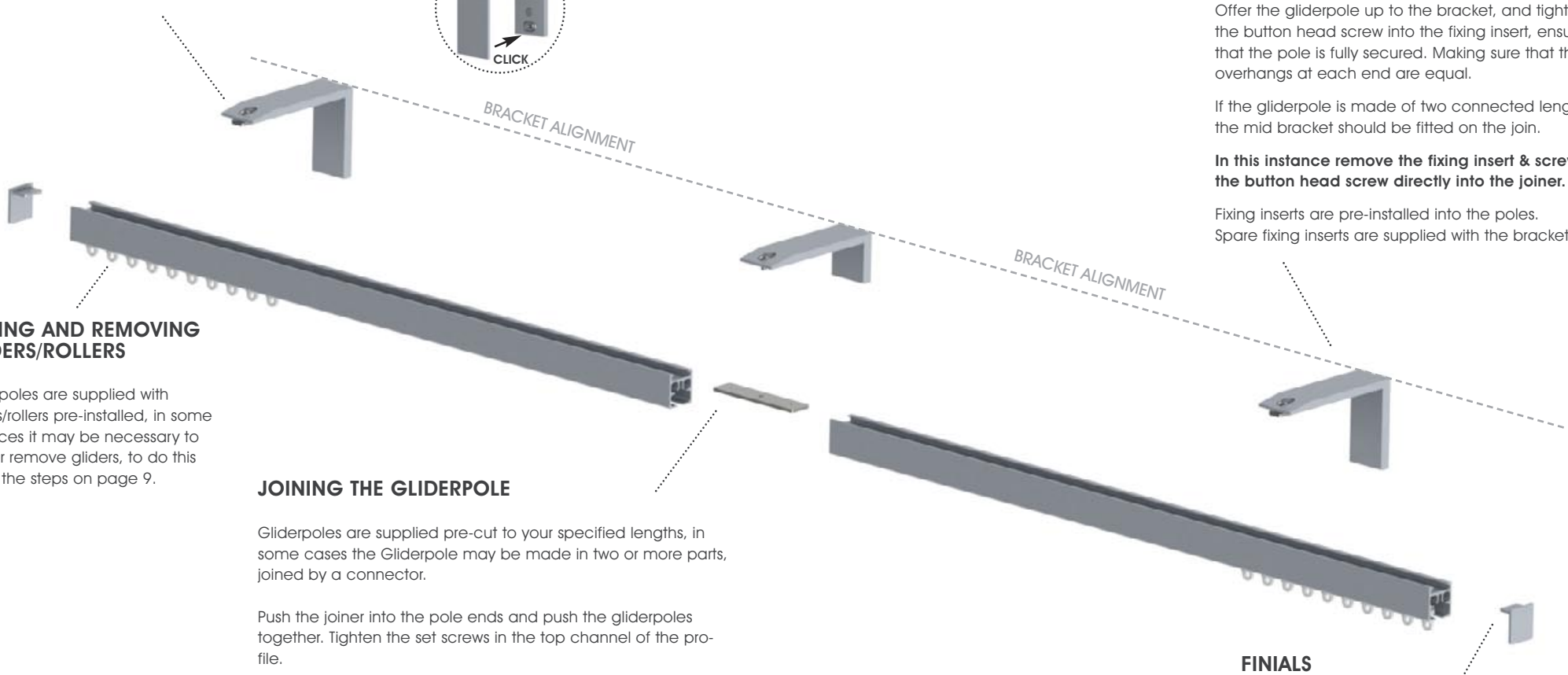

**ADDING AND REMOVING
GLIDERS/ROLLERS**

Gliderpoles are supplied with gliders/rollers pre-installed, in some instances it may be necessary to add or remove gliders, to do this follow the steps on page 9.

JOINING THE GLIDERPOLE

Gliderpoles are supplied pre-cut to your specified lengths, in some cases the Gliderpole may be made in two or more parts, joined by a connector.

Push the joiner into the pole ends and push the gliderpoles together. Tighten the set screws in the top channel of the profile.

- 1 **PLEASE NOTE, All joins must be supported by a bracket.**
If there is a gap between joins gliders/rollers may not run efficiently.

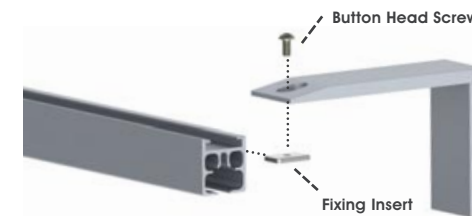

FITTING GLIDERPOLE TO THE BRACKETS

When fitting the track ensure the higher edge of the profile is at the front.



Offer the gliderpole up to the bracket, and tighten the button head screw into the fixing insert, ensuring that the pole is fully secured. Making sure that the overhangs at each end are equal.

If the gliderpole is made of two connected lengths, the mid bracket should be fitted on the join.

In this instance remove the fixing insert & screw the button head screw directly into the joiner.

Fixing inserts are pre-installed into the poles. Spare fixing inserts are supplied with the brackets.

FINIALS

Attach the finials by pushing them into position and tightening the set screws on the finial.

CEILING BRACKETS

Light Duty Ceiling Brackets - Suitable for use with Square • Flat • Round 30mm (1 3/16") Gliderpoles
 Heavy Duty Ceiling Brackets* - Suitable for use with all Gliderpole types

! PLEASE NOTE, Bracket must be secured to the Gliderpole before being fitted to the ceiling.

All joins must be supported by a bracket.

Where gliderpoles join, substitute the T-bar/Fixing insert for a joiner.

- 1 Mark the position of the brackets.
- 2 Drill holes.
- 3 Locate T-bar/Fixing insert into the top of the pole & tighten the counter sunk screw.
- 4 Screw each bracket into position, using suitable fixings.

LIGHT DUTY CEILING BRACKET*

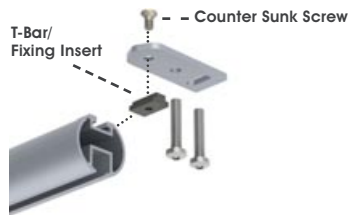

HEAVY DUTY CEILING BRACKET

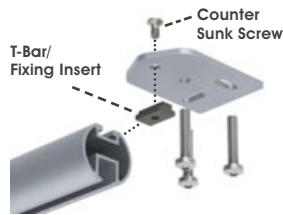

* 50mm (2") Gliderpole not suitable for use with the Light Duty Ceiling Bracket

RECESS BRACKETS

! PLEASE NOTE, Not suitable for use with ceiling brackets

- 1 Mark the position of the brackets.
- 2 Drill holes & use a suitable wall fixing when attaching the plate to the wall.
- 3 Screw each bracket into position.
- 4 Slide the locking tab inside the top of the pole up in to the fix plate.
- 5 Tighten the set screws in both the top of the bracket and top channel of the pole.

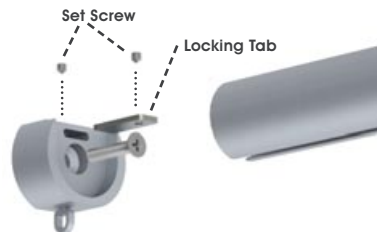

ADJUSTABLE BRACKETS

- 1 Mark the position of the brackets.
For longer poles a mid bracket is required.
- 2 Drill holes & use a suitable wall fixing when attaching the plate to the wall.
- 3 Screw each bracket into position.
- 4 Fit the cover plate, the cover is held in place by magnets.
- 5 Screw in the button head screws into the bracket arm and slide to the desired projection, once the projection is set tighten the screws to ensure the bracket arm is firmly secure.

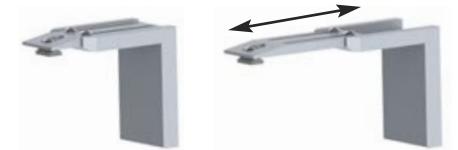
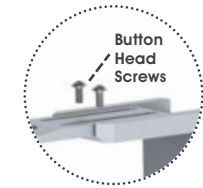

- 6 Offer the gliderpole up to the bracket, and tighten the button head screw into the t-bar, ensuring that the pole is fully secured.
- ! PLEASE NOTE, All joins must be supported by a bracket. where poles join, substitute the T-bar/Fixing insert for a joiner.

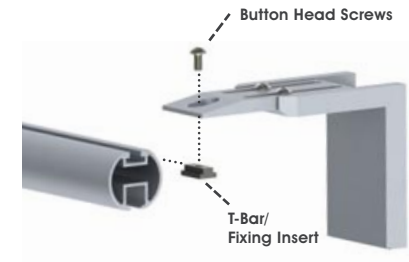

GLIDERPOLE®

ADDING AND REMOVING GLIDERS/ROLLERS

Gliderpoles are supplied with gliders/rollers pre-installed, in some instances it may be necessary to add or remove gliders, to do this follow the steps below

HAND DRAWN

- 1 If fitted remove finial.
- 2 Remove the gliderstop from the bottom channel.
- 3 Add/remove gliders or rollers from the bottom channel.
If using wave ensure that there is an even number or wave gliders/rollers on each stack
- 4 Refit the gliderstop and finial.

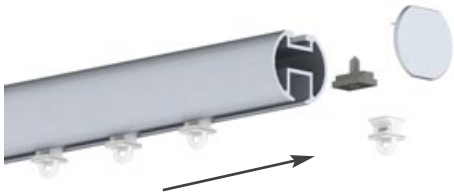

CORDED

- 1 Locate the cord cover on the underside of the track, & unscrew the fixing to remove the cover.
- 2 Add/remove gliders or rollers from the bottom channel.
If using wave ensure that there is an even number or wave gliders/rollers on each stack
- 3 Refit the cover into place & tighten the fixing, taking care not to trap the cord



CORDED GLIDERPOLES WARNING

Young children can be strangled by loops in pull cords, chains, tapes and inner cords that operate the product.

To avoid strangulation and entanglement, keep cords out of the reach of young children. Cords may become wrapped around a child's neck.

- Move beds, cots and furniture away from window covering cords.
- Do not tie cords together.
- Make sure cords do not twist and create a loop.
- Children can be strangled if this safety device is not installed.
- Always use this device to keep cords out of the reach of children.

This retaining device should be installed at the maximum distance possible from the control mechanism to prevent the looped pull cord(s) becoming slack.



- 1 Mark the position of the retainer.
- 2 Drill holes & use a suitable wall fixing when attaching the plate to the wall.
- 3 Screw into position.
- 4 Put pulley wheel onto fixing plate.
- 5 Feed cord through the cover plate and pull into position.
- 6 Slide coverplate down and locate over fixing plate. tighten set screw on the underside.