

Silent Gliss® 4905

Montageanleitung
Fitting sheet
Istruzioni per il montaggio
Instructions de pose

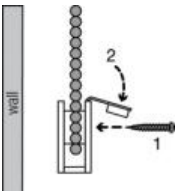

<p>WARNING!</p> <p>Young children can be strangled by loops in pull cords, chains, tapes and inner cords that operate the product. To avoid strangulation and entanglement, keep cords out of the reach of young children. Cords may become wrapped around a child's neck. Move beds, cots and furniture away from window covering cords. Do not tie cords together. Make sure cords do not twist and create a loop.</p> <p>Children can strangle if this safety device is not installed. Always use this device to keep cords and chains out of reach of children.</p>	<p>EN</p> <p>Fixing instruction for the device:</p>  <p>This retaining device should be installed at the maximum distance possible from the control mechanism to prevent the looped pull cord(s) becoming slack.</p>	<p>DE</p> <p>Einbauanweisungen für diese Vorrichtung:</p>  <p>Diese Rückhaltevorrichtung sollte mit dem maximal möglichen Abstand zum Steuerungsmechanismus eingebaut werden, um ein Durchhängen der in einer Schleife aufgerollten Zugschnüre zu verhindern.</p>
<p>AVERTISSEMENT!</p> <p>Les jeunes enfants peuvent s'étrangler avec les nœuds des cordes, chaînes, rubans et cordons internes qui composent ce produit. Pour éviter les risques d'étranglement et d'emmêlement, conservez les cordons hors de la portée des jeunes enfants. Les cordons peuvent s'enrouler autour du cou des enfants. Éloignez les lits, lits d'enfants et meubles des cordons recouvrant les fenêtres. N'attachez pas les cordons. Assurez-vous qu'ils ne se tordent pas et ne créent pas de boucles.</p> <p>Il existe un risque d'étranglement pour les enfants si ce dispositif de sécurité n'est pas installé. Utilisez toujours ce dispositif pour tenir les chaînes et les cordes hors de portée des enfants.</p>	<p>FR</p> <p>Instructions de montage du dispositif :</p>  <p>Ce dispositif de retenue doit être installé à une distance maximale du dispositif de commande pour éviter que les cordes enroulées ne prennent du mou.</p>	<p>IT</p> <p>Istruzioni di fissaggio del dispositivo:</p>  <p>Il fermo di sicurezza deve essere installato alla massima distanza possibile dal meccanismo di controllo per prevenire l'allentamento della(e) corda(e) avvolta(e).</p>
<p>ADVERTENCIA!</p> <p>Los niños pequeños pueden ahogarse con los lazos de las cuerdas de accionamiento, cadenas, cintas y cordones interiores del producto. Para evitar estrangulamientos y/o accidentes, mantenga los cordones fuera del alcance de los niños pequeños. Los cordones se podrían enrollar en el cuello del niño. Coloque las camas, cunas y muebles lejos de los cordones que cubren la ventana. No ate los cordones. Asegúrese de que los cordones no se enreden sobre sí mismos y forman lazos.</p> <p>Los niños se pueden estrangular si este dispositivo de seguridad no está instalado. Use siempre este dispositivo para mantener las cuerdas y las cadenas fuera del alcance de los niños.</p>	<p>ES</p> <p>Instrucciones de fijación para el dispositivo:</p>  <p>Este dispositivo de retención se debe instalar a la mayor distancia posible del mecanismo de control para evitar que los cordones de tiro con bucle se aflojen.</p>	<p>NL</p> <p>Bevestigingsinstructies voor het apparaat:</p>  <p>Dit vergrendelingsmechanisme moet op de maximale afstand van het bedieningsmechanisme worden geïnstalleerd om te voorkomen dat omgewikkelde trekkoorden los komen te hangen.</p>
<p>VARNING!</p> <p>Små barn kan strypas av öglorna i draglinor, kedjor, band och inomhusledningar, som produkten består av. För att undvika strypning och hoptrassling bör du hålla ledningarna utom räckhåll för små barn. Linorna kan komma att viras runt ett barns hals. Avlägsna sängar, babysängar och möbler från fönster som täcker ledningarna. Bind inte ihop ledningarna. Kontrollera att ledningarna inte viras ihop och skapar en ögla.</p> <p>Barn kan strypas om den här säkerhetsanordningen inte monteras. Använd alltid denna anordning för att hålla linor och kedjor utom räckhåll för barn.</p>	<p>SE</p> <p>Instruktion för festsättning av anordningen:</p>  <p>Den här säkerhetsställaren ska monteras på längsta möjliga avstånd från styrmekanismen för att förhindra att de ögelformade draglinorna blir slaka.</p>	<p>DK</p> <p>Monteringsvejledning:</p>  <p>Denne fastholdelsesanordningen bør installeres så langt som muligt fra kontrolmekanismen, således at den snoede snor ikke bliver for løs.</p>

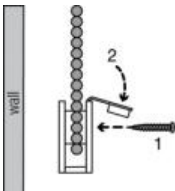
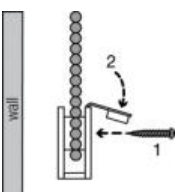
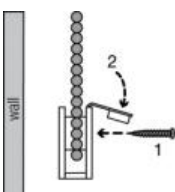
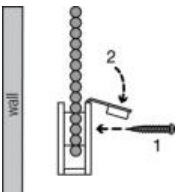
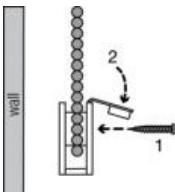
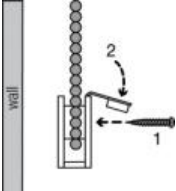
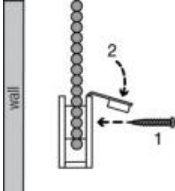

Silent Gliss® 4905

Montageanleitung
Fitting sheet
Istruzioni per il montaggio
Instructions de pose

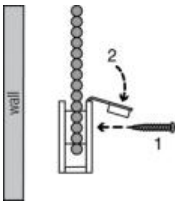
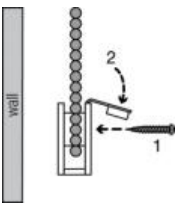
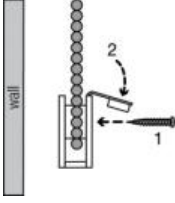
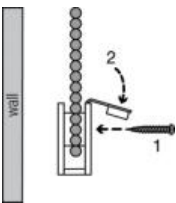
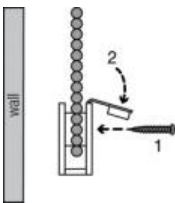
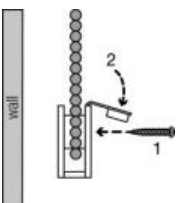
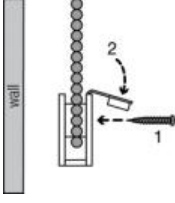

<p>ADVARSEL!</p> <p>Små barn kan bli kvalt av løkker i trekkstnorer, kjeder, tape og indre snorer som brukes til å betjene produktet. For å unngå kvelning og innvikling, må snorene være utligelig for små barn. Snorene kan vikle seg rundt barnets nakke. Flytt senger, barnesenger og møbler vekk fra snorer som henger ned fra vinduer. Snorene må ikke knytes sammen. Pass på at snorene ikke vrir seg og lager en løkke.</p> <p>Barn kan bli kvalt hvis denne sikkerhetsanordningen ikke blir montert. Bruk alltid denne anordningen for å holde snorer og kjeder utenfor barns rekkevidde.</p>	<p>VAROITUS!</p> <p>Tuotteen narujen, ketjujen, nauhojen ja sisänarujen silmukat muodostavat kuristumisvaaran pienille lapsille. Pidä narut poissa pienten lasten ulottuvilta kuristumisen ja kietoutumisen välttämiseksi. Narut voivat kietoutua lapsen kaulan ympärille. Siirrä vuoteet, kehdot ja huonekalut pois ikkunanpöytästä narujen läheisyydestä. Älä solmi naruja yhteen. Varmista, että narut eivät kierry ja muodosta silmukkaa.</p> <p>Lapset voivat kuristua, mikäli tätä turvalaitetta ei ole asennettu. Käytä tätä laitetta aina pitämään narut ja ketjut poissa lasten ulottuvilta.</p>	<p>FI</p> <p>Laitteen kiinnitysohje:</p>  <p>Tämä varmistinlaite on aina asennettava mahdollisimman suurelle etäisyydelle säätölaitteesta, jotta silmukan muodostava(t) vetonaru(t) ei(vät) ole löyh(ä).</p>
<p>ПРЕДУПРЕЖДЕНИЕ!</p> <p>Маленькие дети могут задыхаться в петлях натяжных шнуров, цепочек, лент и внутренних шнуров управления продуктом. Во избежание удушья и запутывания следите за тем, чтобы шнуры оставались вне досягаемости маленьких детей. Шнуры могут затянуться вокруг шеи ребенка. Отодвиньте кровати, детские кроватки и прочую мебель от шнуров оформления окон. Не перевязывайте шнуры друг с другом. Следите за тем, чтобы шнуры не переплетались и не образовывали петлю.</p> <p>Если данное защитное приспособление не будет установлено, существует опасность удушья для детей. Обязательно используйте данное приспособление для того, чтобы шнуры и цепи оставались вне досягаемости детей.</p>	<p>RU</p> <p>Инструкции по закреплению приспособления:</p>  <p>Во избежание провисания петель шнура(-ов) данное удерживающее приспособление должно быть установлено на максимально возможном расстоянии от механизмов контроля.</p>	<p>GR</p> <p>Καθορισμός χρήσης της συσκευής:</p>  <p>Αυτή η συσκευή συγκράτησης πρέπει να εγκατασταθεί στη μέγιστη δυνατή απόσταση από τον μηχανισμό ελέγχου για την πρόληψη και αποφυγή των τυλιγμένων καλωδίων να καταστύουν χαλαρά.</p>
<p>UYARI!</p> <p>Küçük çocuklar ürünü çalıştıran çekme kordonları, zincirler, bantlar ya da iç kısımlardaki iplerdeki döngüler nedeniyle boğulabilirler. Boğulma ve dolanmanın önlenmesi için kordonları küçük çocukların ulaşamayacağı yerlerde tutunuz. Kordonlar çocuğun boynuna sarılabılır. Yatakları, beşikleri / karyoları ve eşyaları, pencereleri kaplayan kordonlardan uzağa taşıyın. Kordonları birbirine bağlamayın. Kordonların kırılıp döngü oluşturmadığından emin olun.</p> <p>Eğer bu güvenlik aleti monte edilmemiş ise çocuk boğulabilir. Bu aleti her zaman kordonları ve zincirleri çocukların erişiminden uzak tutmak için kullanın.</p>	<p>TR</p> <p>Alet için tamiir açıklamaları:</p>  <p>Bu tutma aleti kontrol mekanizmasından mümkün olan en uzak mesafeye monte edilmelidir ki kvrılan / dönen çekme kordonu (ları) boşalmsın.</p>	<p>MT</p> <p>Struzzjonijiet biex jitwahhal it-tagħmir:</p>  <p>Dan it-tagħmir tal-irbit għandu jiġi installat kemm jista' jkun 'il bogħod mill-mekkanizmu ta' kontroll sabiex jiġi evitat li l-kurdun/i tal-ġbid jillaxkaw.</p>
<p>警告</p> <p>兒童有可能因纏繞本產品的拉繩、索鏈、簾帶和內置拉繩而窒息身亡。為避免勒束窒息的危險，請將拉繩置於兒童接觸不到的地方。拉繩可能導致兒童頸部被纏繞。窗戶拉繩附近請勿放置小床和傢俱。請勿將拉繩綁在一起。確保勿將拉繩扭轉或打結。</p> <p>如果未安裝此安全裝置，可能會勒住兒童而產生窒息危險。請始終使用該安全裝置，保管電源線和鏈條至兒童無法觸及的位置。</p>	<p>CN</p> <p>装置安装说明</p>  <p>该止动装置应尽可能地安装在与控制机械装置距离最远的地方，防止环形控制线松弛。</p>	<p>JP</p> <p>装置の取り付け方</p>  <p>本保持装置は制御機構から最も遠い所に取り付け、ループ状のプルコードがたるまないようにしてください。</p>



Silent Gliss® 4905

Cord / Chain Safety Retainer Silent Gliss 10731

Montageanleitung
Fitting sheet
Istruzioni per il montaggio
Instructions de pose

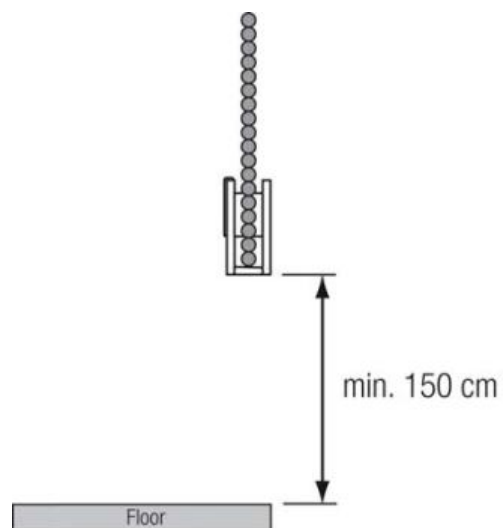
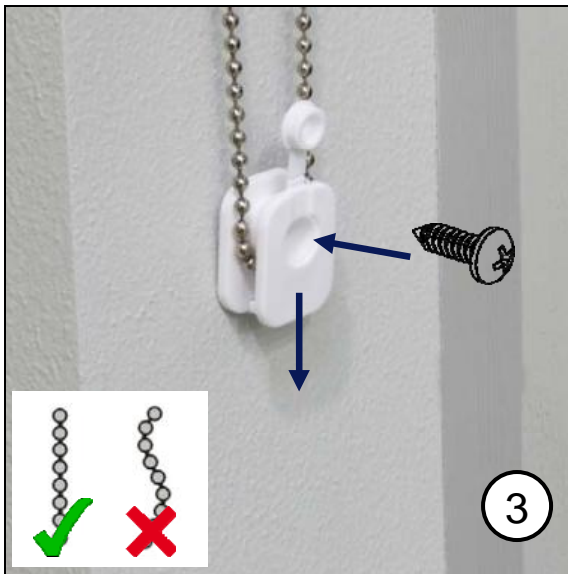

Silent Gliss® 4905

Montageanleitung (Decke)
 Fitting sheet (ceiling)
 Istruzioni per il montaggio (soffitto)
 Instructions de pose (plafond)

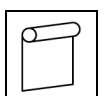
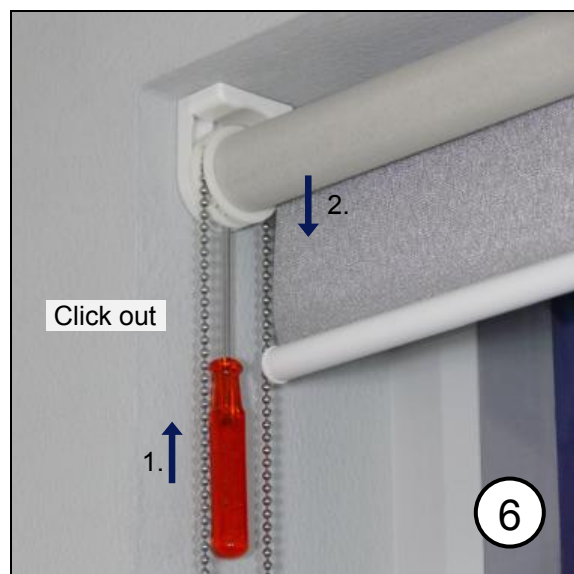
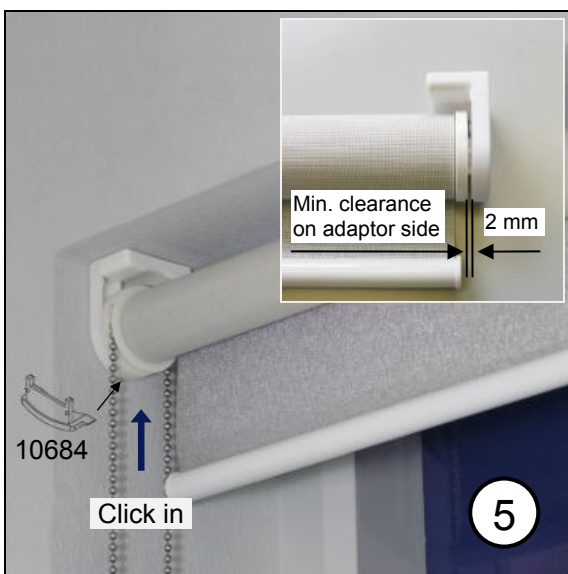
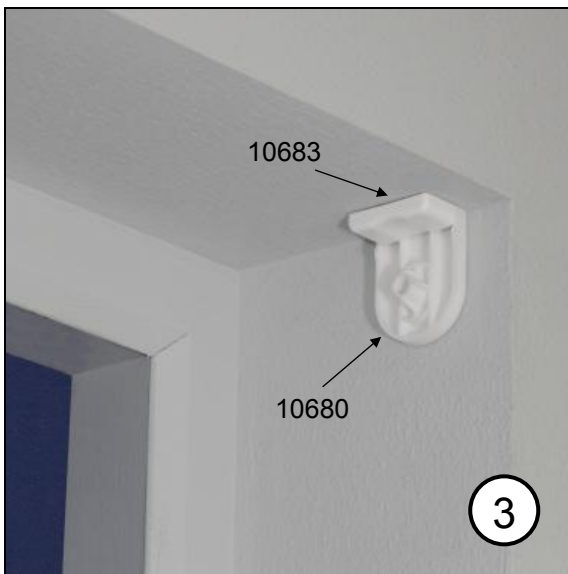
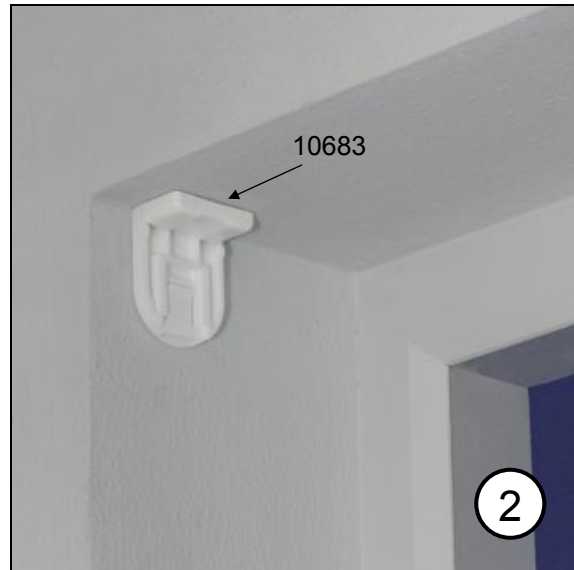
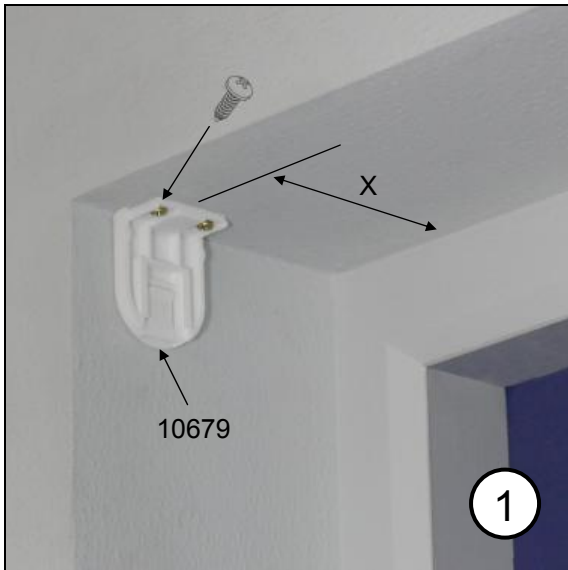

Silent Gliss® 4905

Montageanleitung (Wand)
 Fitting sheet (wall)
 Istruzioni per il montaggio (murale)
 Instructions de pose (murale)

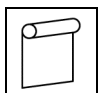
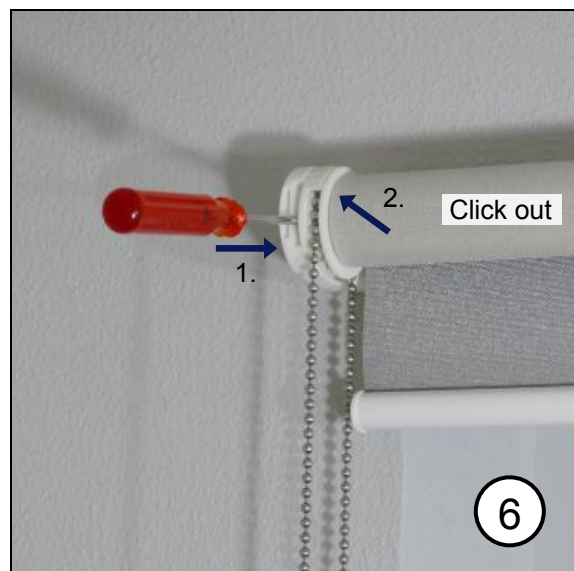
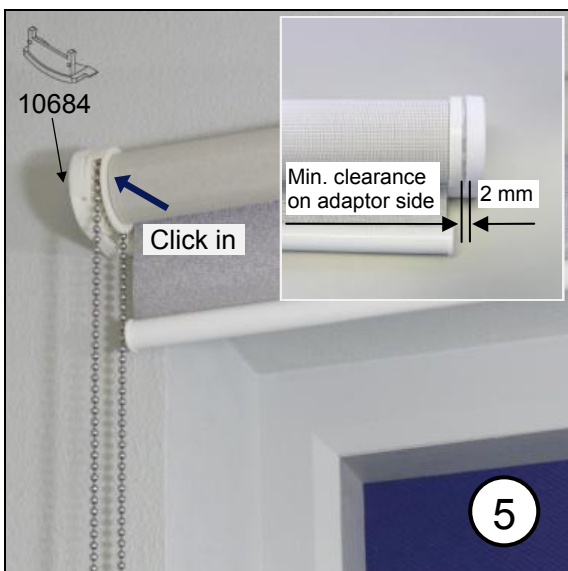
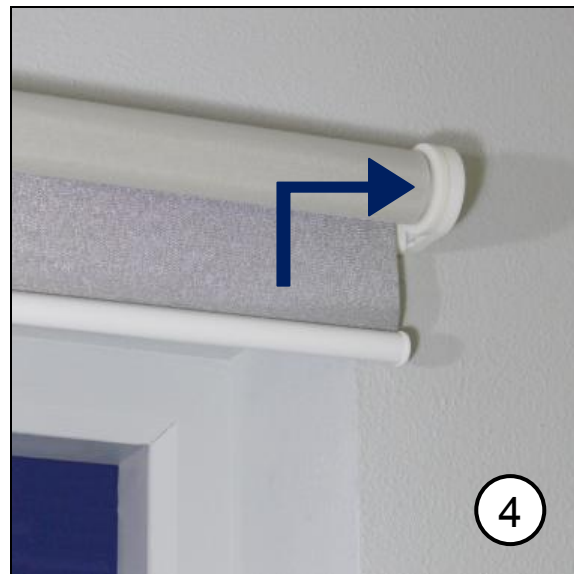
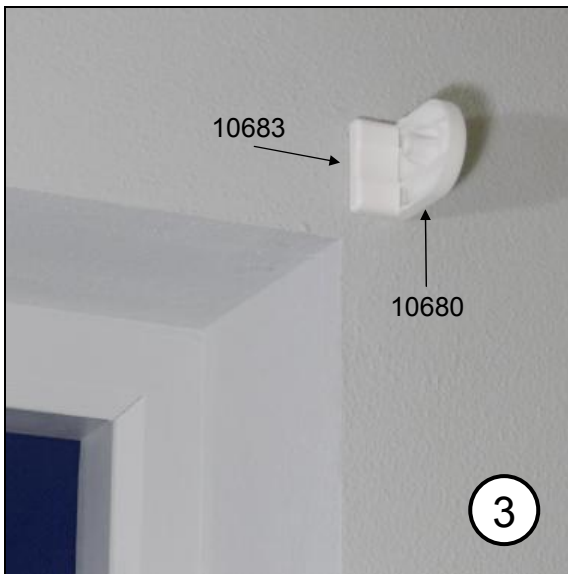
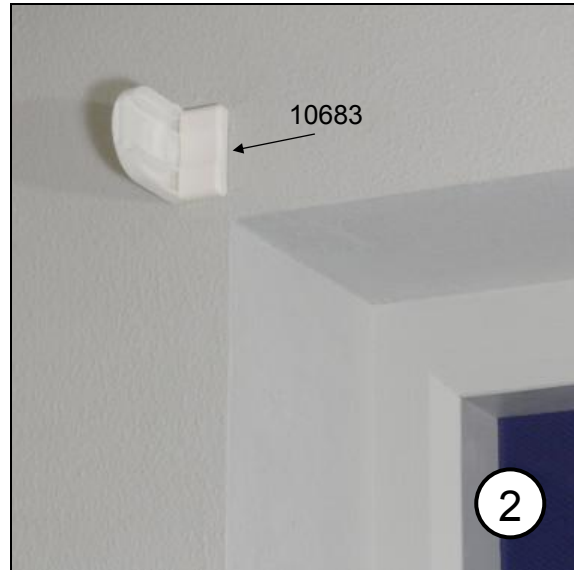
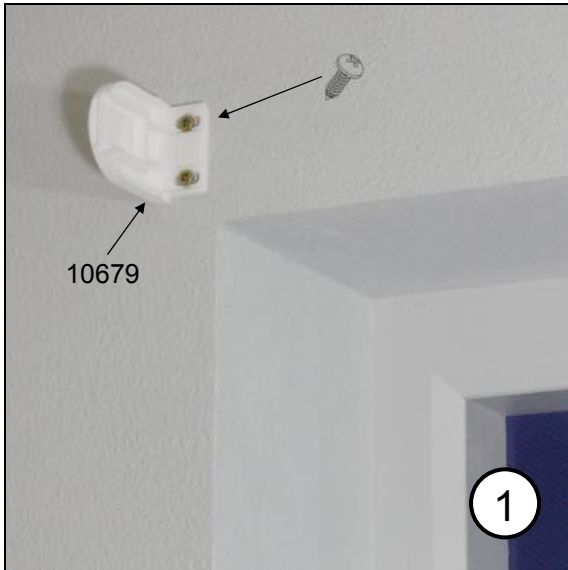

Silent Gliss® 4905

Montageanleitung (Wand) – Seitenführung
Fitting sheet (wall) – Side guide
Istruzioni per il montaggio (murale) – Guida laterale
Instructions de pose (murale) – Guidage latéral

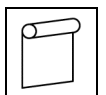
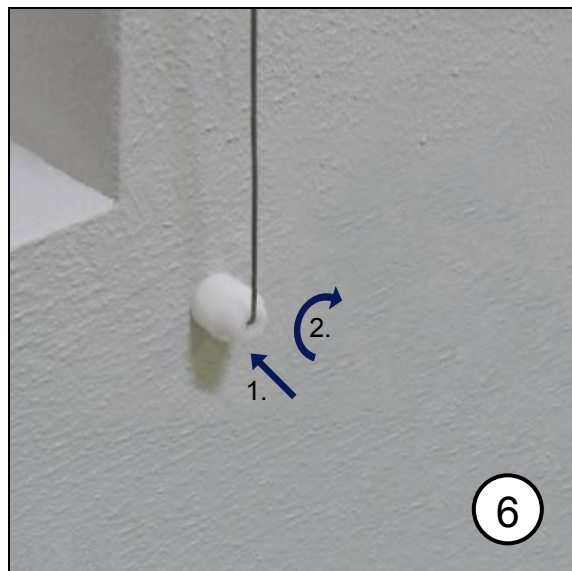
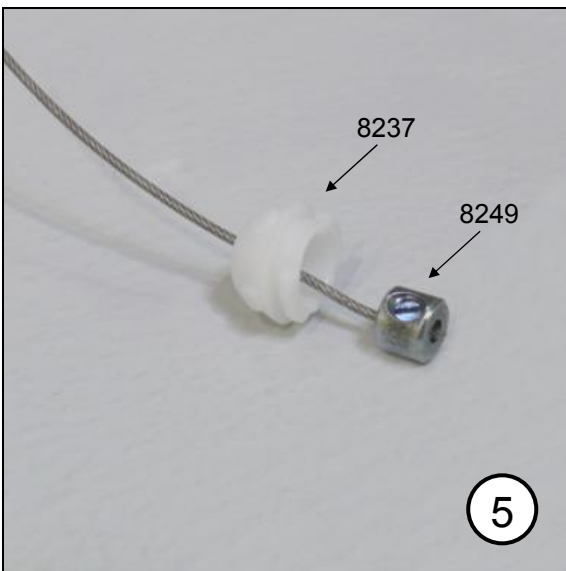
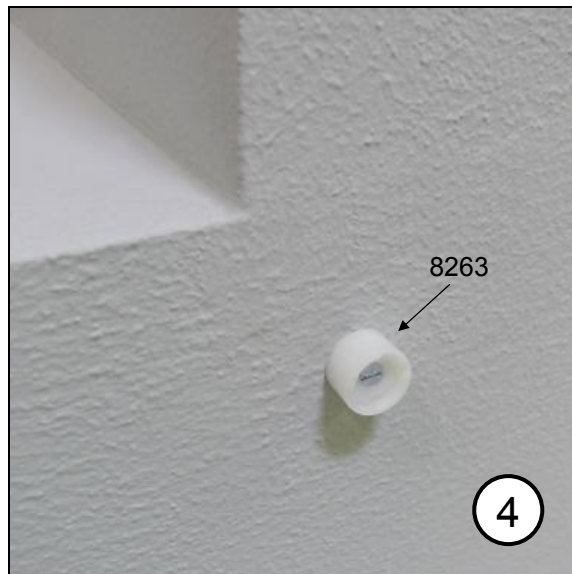
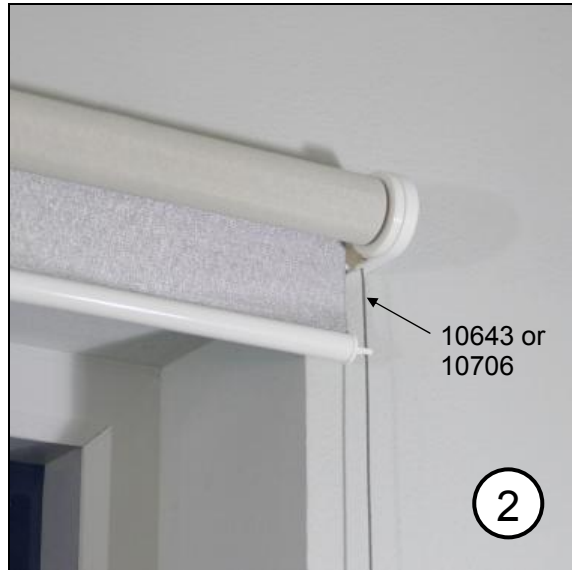
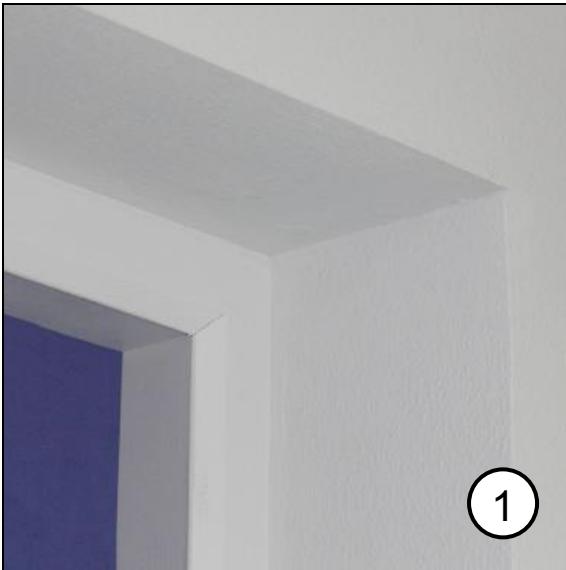

Silent Gliss® 4905

Montageanleitung (Wand) – Seitenführung
 Fitting sheet (wall) – Side guide
 Istruzioni per il montaggio (murale) – Guida laterale
 Instructions de pose (murale) – Guidage latéral

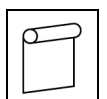
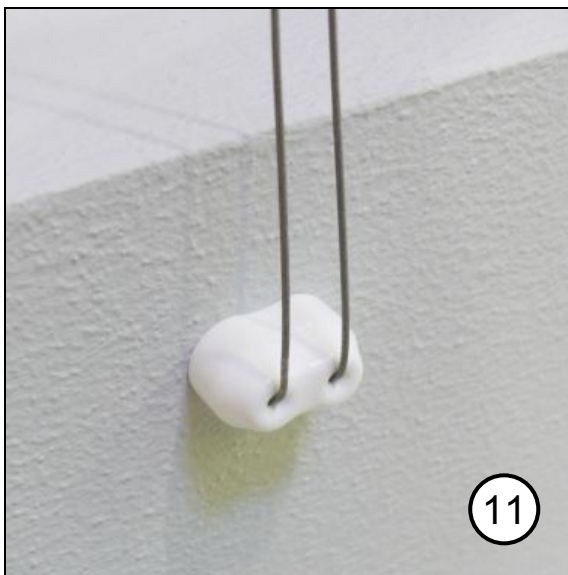
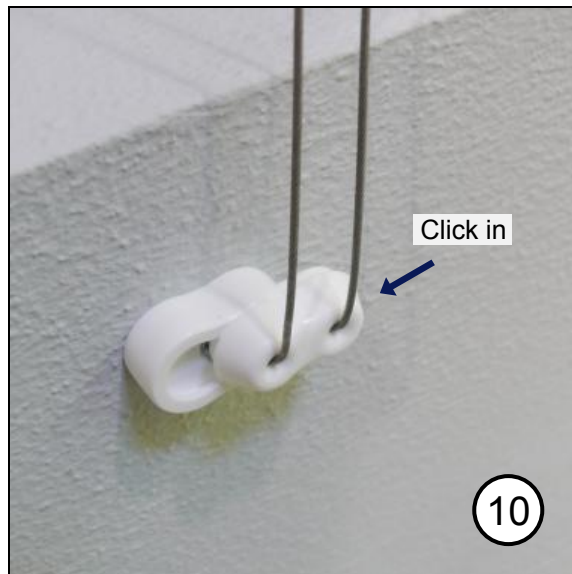
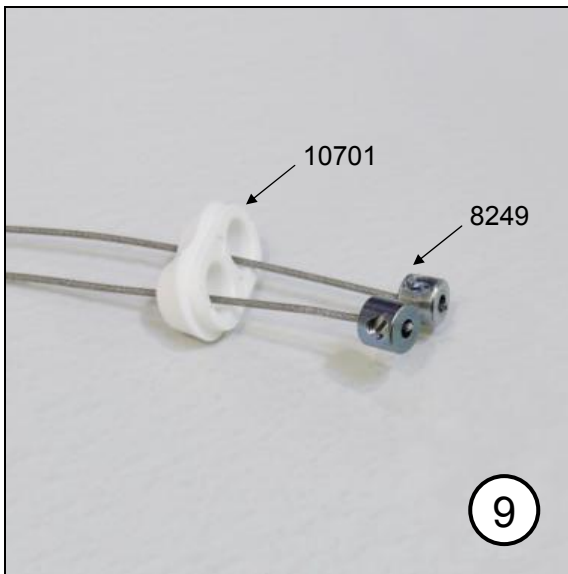
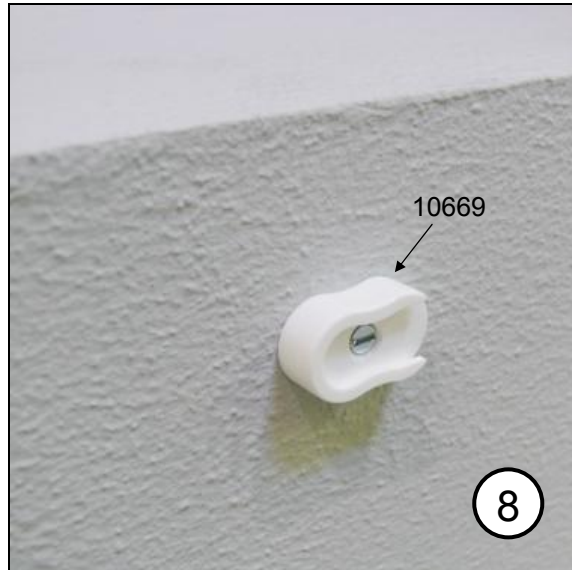
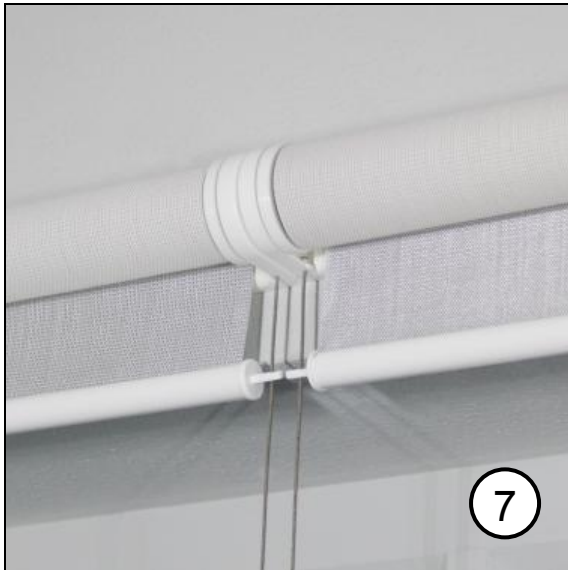

Silent Gliss® 4905

Montageanleitung (Decke) – Seitenführung
 Fitting sheet (ceiling) – Side guide
 Istruzioni per il montaggio (soffitto) – Guida laterale
 Instructions de pose (plafond) – Guidage latéral

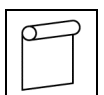
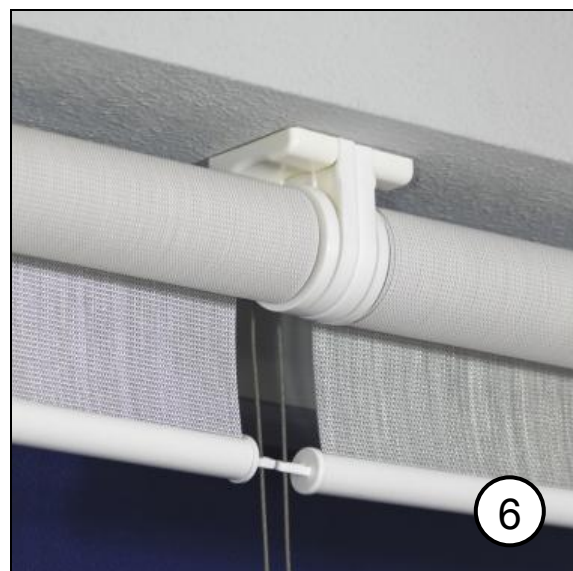
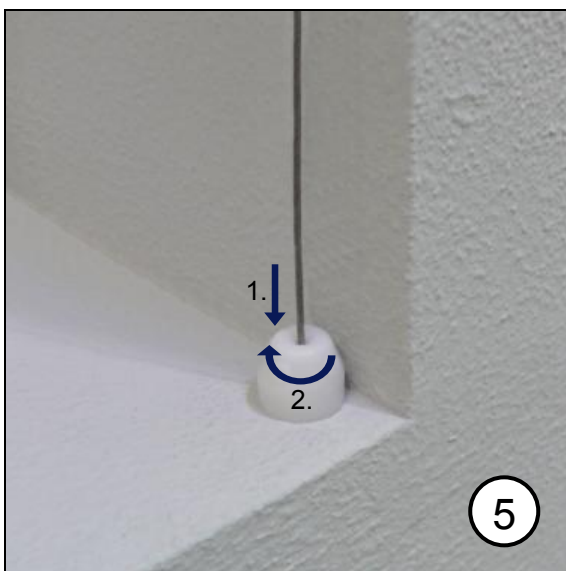
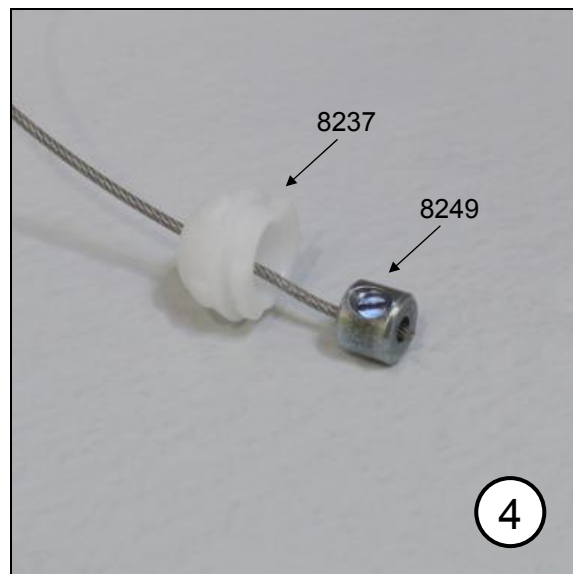
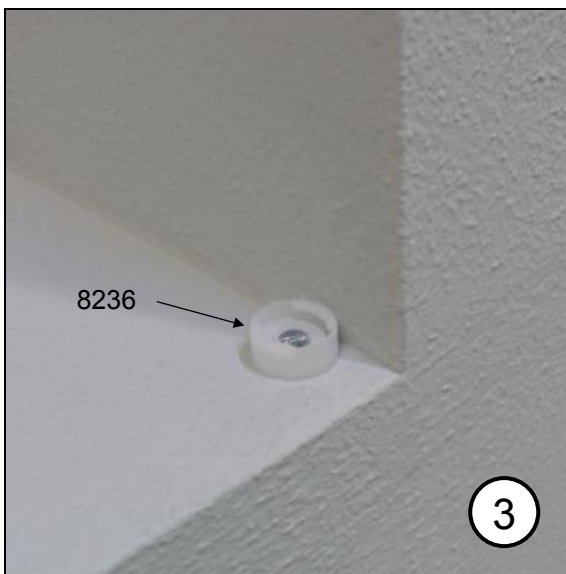
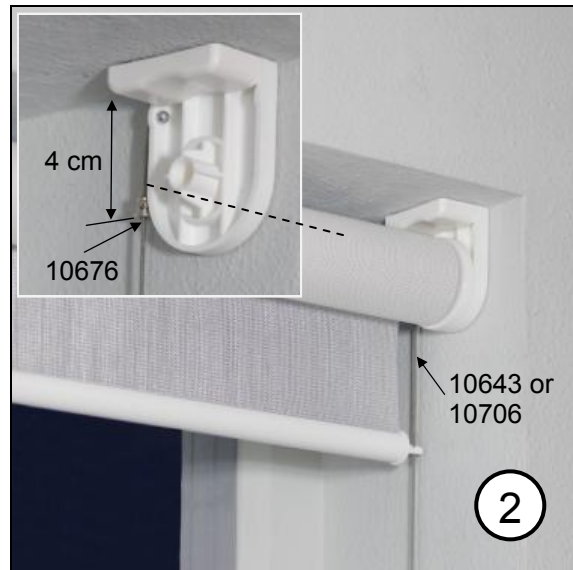
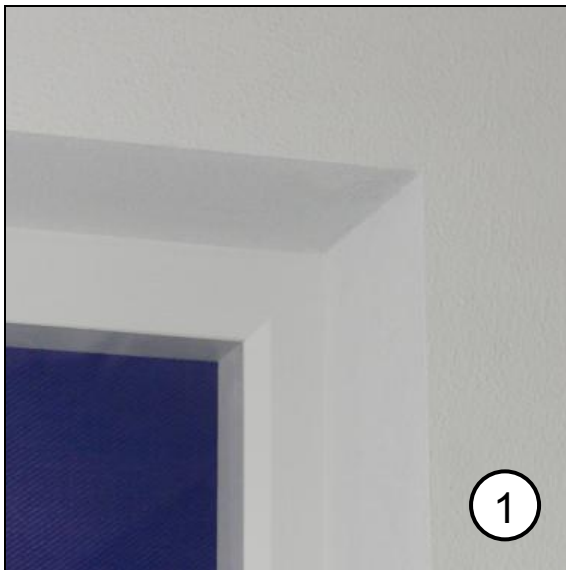

Silent Gliss® 4905

Montageanleitung (Decke) – Seitenführung
Fitting sheet (ceiling) – Side guide
Istruzioni per il montaggio (soffitto) – Guida laterale
Instructions de pose (plafond) – Guidage latéral

